



 CENTURIO PRO

 CENTURIO POOL



This manual contains safety information that if ignored can endanger life or result in serious injury. They are indicated by this icon.



Keep the CONTROLLER protected from sun and water. Avoid water splashes.



Depending on chosen configuration, controller's main screen may appear different and some functions couldn't be present.



## “CENTURIO PRO” & “CENTURIO POOL” Controllers Operating Manual

 ERMES

REMOTE CONTROL AND SETUP  
[www.ermes-server.com](http://www.ermes-server.com)



Read Carefully !



ENGLISH Version  
R25-07-21

NORME CE  
EC RULES (STANDARD EC)  
NORMAS DE LA CE



Direttiva Bassa Tensione }  
Low Voltage Directive } 2014/35/UE  
Directiva de baja tensión }

Direttiva EMC Compatibilità Elettromagnetica }  
EMC electromagnetic compatibility directive } 2014/30/UE  
EMC directiva de compatibilidad electromagnética }

## GENERAL SAFETY GUIDELINES



**Danger!** In emergencies the CONTROLLER should be switched off immediately! Disconnect the power cable from the power supply!

When installing always observe local regulations!

Manufacturer is not liable for any unauthorized use or misuse of this product that may cause injury, damage to persons and / or materials.

**Caution!** CONTROLLER must be accessible at all times for both operating and servicing. Access must not be obstructed in any way!

Feeder should be interlocked with a no-flow protection device to automatically shut-off connected pumps when there is no flow!

Pumps and connected accessories must be serviced and repaired by qualified and authorized personnel only!

Always discharge the liquid end before servicing pumps connected to the CONTROLLER!

Empty and rinse the liquid end before work on a connected pump which has been used with hazardous or unknown chemicals!

Always read chemical safety datasheet!

Always wear protective clothing when handling hazardous or unknown chemicals!

CONTROLLER must be operated / serviced by trained technicians only!

All connection operations must be performed while the CONTROLLER is not connected to main supply!

Missed activation for Min/Max alarm and Maximum Dosing Alarm may cause hazardous overdosing!

# Introduction

"Centurio PRO" is a multi-measure digital controller capable of simultaneously controlling up to 10 programmable channels for pH \* - Redox (ORP) - Chlorine - Turbidity - Temperature - Combined Chlorine (see Chlorine configuration) features - Chlorine Total (see Chlorine function for the configuration) - Tracers - Conductivity - Dissolved oxygen - Potentiostatic. The controller has 6 setpoints outputs, 6 proportional outputs, 6 mA outputs, 1 probe cleaning output and 5 product tank level inputs. The controller can be connected to a PC, even remotely, for remote control of the system via USB, RS485, MODEM GSM or GPRS, ETHERNET. The working scales of the controller are:

- pH: from 0 to 14 pH
- Redox (ORP): from 0 to 1000 mv
- Chlorine (combined / total): from 0 to 10 mg/l
- Tracers: from 0 to 999.9 PPM
- mA Input 0/4-20 mA
- Turbidity: from 0 to 9999 NTU
- Potentiostatic: 5 PPM
- Temperature: from 0 to 200 ° C
- Conductivity: from 0 to 300.0 mS
- Conductivity Ind.: from 0 to 30.000 uS
- Dissolved Oxygen: 0 to 20 mg/l

**Conductivity and optional modules:** pH, Tracer, Chlorine Meter with Proportional and Digital outputs, Generic mA channel

## The wheel and the touch screen

The controller can be operated using both the wheel and the touch screen controls. The wheel is located below the screen and can be both rotated and pressed to confirm operations.



Swipe or Tap



Rotate and Press

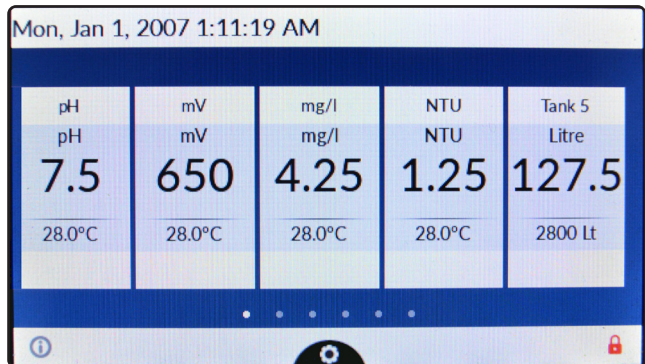

Tap to confirm changes (right corner screen)



Tap to discard changes and return to previous menu (left corner screen)



Tap to return to main screen

**A RED COLOR BAR WITHIN A CHANNEL REQUIRES USER ATTENTION - TAP ON IT FOR FURTHER INFORMATION**

The capacitive touch screen could not work while wearing gloves. If you need to wear them for safety reason please use a capacitive stylus to operate controller's screen. Some functions can be performed using the touch screen only.

# Mainboard connections

Unplug CONTROLLER from main power supply then perform connections by following the picture below.  
 For easy understanding the board has been divided into two parts: **I/O connections** and **Power - Relays connections**.  
**For mA outputs and optional communication connections (I.E: Modbus) refer to page 35.**

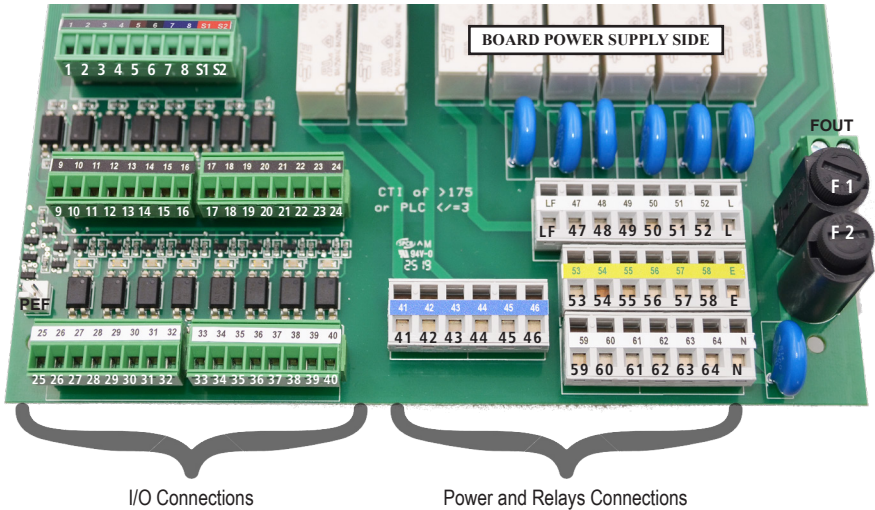

## Fuses:

F1: **Main Power Fuse** (6,3A T)  
 F2: **CONTROLLER Fuse** (3.15A T)

**S1(+)** - **S2(GND)**: Standby  
**PEF**: Connector for PEF LIGHT ALARM  
**FOUT**: Remove jumper to disable L(LIVE) from RELAYS OUTPUTS

## Power and Relays Connections:

L(Live) - E(Earth) - N(Neutral): **Main power supply** 230VAC (85-264VAC, 50/60Hz) or 24VAC\* 50/60 Hz  
 LF (LIVE FUSE PROTECTED): Live input for motorized EV

\*see controller's label

41(N.C. contact) - 42(Common) - 43(N.O. contact): **Free of voltage contact** (max insulation 250V) **RELAY n.1**  
 44(N.C. contact) - 45(Common) - 46(N.O. contact): **Free of voltage contact** (max insulation 250V) **RELAY n.2**

47(L) - 53(E) - 59(N): **Setpoint RELAY n.3**  
 48(L) - 54(E) - 60(N): **Setpoint RELAY n.4**  
 49(L) - 55(E) - 61(N): **Setpoint RELAY n.5**  
 50(L) - 56(E) - 62(N): **Setpoint RELAY n.6**  
 51(L) - 57(E) - 63(N): **Setpoint RELAY n.7**  
 52(L) - 58(E) - 64(N): **Setpoint RELAY n.8**



Warning: Connections must be performed by qualified and trained personnel only

Completely Configurable Connections  
 (i.e.: ALARM)

**I/O Connections:**

1(+); 2(-): **Pulse Sender Water Meter** input n.1 (WM1) max 300Hz  
 3(+); 4(-): **Pulse Sender Water Meter** input n.2 (WM2) max 300Hz

5(+ Brown) - 6(Black) - 7/8(- Blue ; GND): **Flow sensor** mod. "SEPR" (don't remove jumper between blocks 7 and 8)\*  
 \*to use it as free of voltage contact leave jumper on blocks 7 and 8 and use blocks 5 and 6 as contact

9(+); 10(-): **Level** input n.1  
 11(+); 12(-): **Level** input n.2  
 13(+); 14(-): **Level** input n.3  
 15(+); 16(-): **Level** input n.4  
 17(+); 18(-): **Level** input n.5  
 19(+); 20(-): **Level** input n.6  
 21(+); 22(-): **Level** input n.7  
 23(+); 24(-): **Level** input n.8

25(-); 26(+): **Proportional pump (driven by pulses, optocoupled signal)** output n.1 NPN max 50mA / 24VDC  
 27(-); 28(+): **Proportional pump (driven by pulses, optocoupled signal)** output n.2 NPN max 50mA / 24VDC  
 29(-); 30(+): **Proportional pump (driven by pulses, optocoupled signal)** output n.3 NPN max 50mA / 24VDC  
 31(-); 32(+): **Proportional pump (driven by pulses, optocoupled signal)** output n.4 NPN max 50mA / 24VDC  
 33(-); 34(+): **Proportional pump (driven by pulses, optocoupled signal)** output n.5 NPN max 50mA / 24VDC  
 35(-); 36(+): **Proportional pump (driven by pulses, optocoupled signal)** output n.6 NPN max 50mA / 24VDC  
 37(-); 38(+): **Proportional pump (driven by pulses, optocoupled signal)** output n.7 NPN max 50mA / 24VDC  
 39(-); 40(+): **Proportional pump (driven by pulses, optocoupled signal)** output n.8 NPN max 50mA / 24VDC

**Modules Code Numbers:**

00274991	CD
00276991	CDIND
00277001	CDSIND
00278101	CL4/5/6
00280931	EOLUM
00281071	FL
00279561	INPUT mA
00280361	OUT mA
00276391	TRC

00274971	PH
00280181	PS
00274981	RH
00276381	SCL
00281431	TORB2
00280101	TORB2IM
00277391	TORBH



Power and Relays Connections must be opened inserting a screwdriver's tip in the upper part of module and inserting the wire in the lower part as shown in left picture!

Wires in the "I / O Connections" terminals can be inserted by first removing the block from the board to facilitate the installation operation.



Warning: Connections must be performed by qualified and trained personnel only

# “Centurio PRO” main screen.

Local Date / Time Mon, Jan 1, 2007 1:11:19 AM Network Connection

Channels / Units

Channels readings

pH	mV	mg/l	NTU	Tank 5
7.5	650	4.25	1.25	127.5
28.0°C	28.0°C	28.0°C	28.0°C	2800 Lt

Channels status

Tap on gear icon for settings menu

Pulse sender water meters for input / bleed (see settings to configure)

**Please note: main screen aspect may change due to installed modules / channels available (1 conductivity channel for basic tower functions plus up to 4 more channels)**



These dots represent how many screens are available for actual viewing. Swipe on screen to scroll between them.

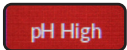

For more info about channel status (alarms, readings, etc..) tap on it for a “in-depth” explanation popup.



For more info about serial number / ERMES code tap on it to see an explanation popup. Red icon requires user attention. Please tap on it for further information.



For more info about ETHERNET / USB / ERMES network connection and settings tap on it.



Tap on “X” icon to discard changes / Tap on “tick” icon to save changes.



Actual screen can be scrolled up or down for more options.



# “Centurio PRO” basic settings.

**Basic settings are:** PASSWORDs, Time & Date, Language and International Units.

**Standard settings are:** Probes calibration and working modes (bleed - inhibitor - biocide).

**Advanced settings are:** Flow meter, Alarm and Communication (WiFi, Mobile, ERMES) menu.

All these three settings must be set in order to properly operate the CONTROLLER.

## PASSWORD for main menu (settings) access.

To grant access into main menu tap on  from main screen and enter the PASSWORD using the keypad on the right side of the screen. Default PASSWORD is 0000 (factory preset).

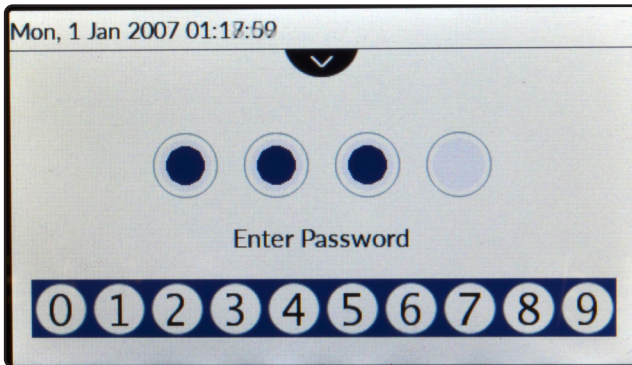

To set a new PASSWORD choose "PASSWORD" from "Settings" menu and enter a four numbers code. Confirm changes to activate the new PASSWORD.

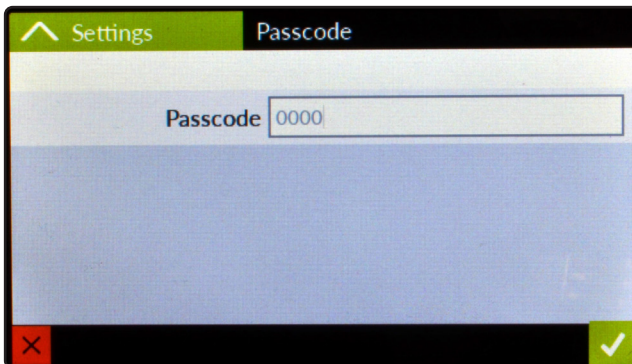

---

### Lost PASSWORD ?

Please don't forget the PASSWORD (if changed). In the unfortunate event, please call your local distributor for unlocking procedure. There is no way for you to recover a lost PASSWORD.

## International.

Before to program the controller please setup Language, Location and local Time & Date (Settings / International). Since the controller activities are based on time is essential to setup time and date prior to anything. Within International menu please choose language and location for proper units format.

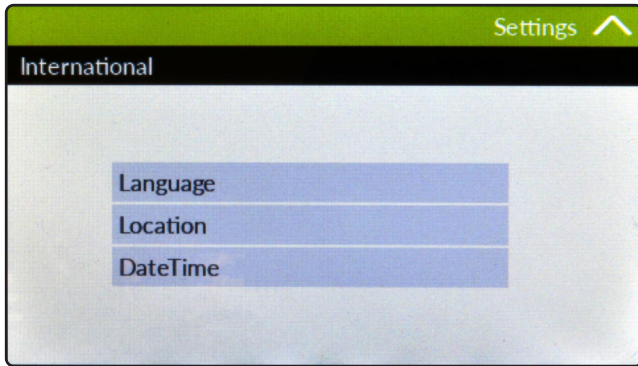

Based on location units change according to local rules. To end procedure tap on tick icon for each change.

EUROPE IS (International Standard)	USA
Date (DD/MM/YY)	Date (MM/DD/YY)
Time 24h	Time AM / PM
°C Celsius	°F Fahrenheit
Liters	Gallons





## “Centurio PRO” standard settings.

Standard settings are: Probes calibration and operating modes (bleed - inhibitor - biocide). To calibrate each channel select it within main menu. Channels availability is based on modules configuration. The controller will automatically add the proper channel when a new module is installed and detected.

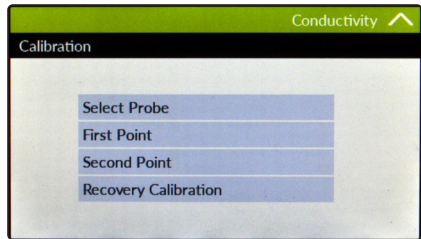
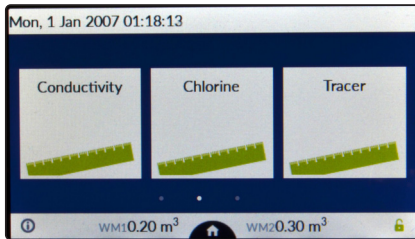

## Conductivity calibration menu.

This menu includes probe choice, conductivity calibration, temperature compensation and manual or automatic temperature compensation. Conductivity calibration procedure involves a zero calibration (First Point) and a 2nd calibration point (Second Point) that requires a buffer solution with value near working range. Furthermore Temperature and Automatic Compensation must be set. **Note: This procedure assumes that CONTROLLER is correctly installed and configured, connected to a working probe. Calibrate using plant's temperature otherwise unattended results might occur. If something wrong occurs use RECOVERY CALIBRATION to restore to previous calibration.**

### First Point & Second Point.

During this procedure probe must be dry and clean and not installed in plant. Tap on “First Point” (zero) and confirm it. Tap on “Second point”, dip probe's head into buffer solution and wait until reading value is stable, enter buffer solution value and confirm it.

### Temperature Compensation (if available)

Conductivity measurements are temperature dependent. The degree to which temperature affects conductivity varies from solution to solution and can be calculated using the following formula:  $C_{25} = C / \{1 + [a/100(t-25)]\}$  where:  $C_{25}$  = slution conductivity at 25°C, C = conductivity at operating temperature, a = temperature coefficient of solution %/°C.

Probe read value (uS or ppm)	Alpha (a)	Temperature (°C / °F)	Displayed Value (us or ppm)
5227	1.2	35°C / 95°F	4934
4524	3.5	27°C / 80.6°F	4228
3924	2.1	40°C / 104°F	2984

Samples alphas (a) are listed in the table above. To determine that “a” of other solutions, simply measure conductivity at a range of temperatures and graphic the change in conductivity versus the change in temperature. “Centurio PRO” has either fixed or adjustable automatic temperature compensation referenced to a standard temperature of 25°C.

Otherwise choose automatic temperature compensation and set % Alpha value.

## Chlorine calibration menu.

Chlorine calibration procedure is based on installed chlorine probe and may involve one or two calibration points depending on probes' model (see table at next page). From main menu choose "Chlorine" then tap on "Calibration". Installed probe will be automatically detected and according to model a one or two points calibration will be enabled.

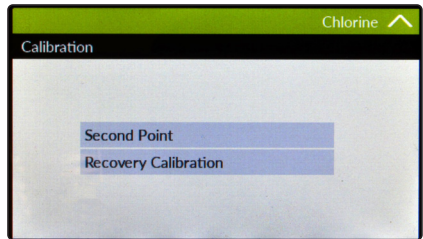
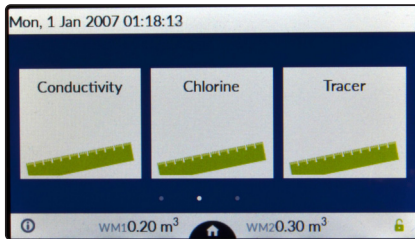

**Note:** This procedure assumes that CONTROLLER is correctly installed and configured, connected to a working probe. Calibrate using plant's temperature otherwise unattended results might occur. If something wrong occurs use RECOVERY CALIBRATION to restore to previous calibration.

### Two points calibration method.

During this procedure probe must be dry and clean and not installed in plant. Use chlorine free water (or a carbon filter system) and dip probe's head into it, wait until reading is stable, then ap on "First Point" (zero) to confirm it.

For Second point calibration use a plant's sample water and analyze it using a DPD system to obtain value. Enter this value as second point calibration and confirm it.

### One point calibration method (second point).

For Second point calibration use a plant's sample water and analyze it using a DPD system (photometer) to obtain value. Enter this value as second point calibration and confirm it.



Carbon Filter System



Photometer

## Chlorine probes table.

Use this table to refer to calibration method to use.

Probe's model	Scale reading	Max reading value	
Scl 1/2	Cl2	2.000	Two Points Calibration
Scl 1/5	Cl2	5.000	
Scl 1/20	Cl2	20.00	
Scl 1/200	Cl2	200.0	
Scl 2/2	ClO2	2.000	Two Points Calibration
Scl 2/20	ClO2	20.00	
Scl 3/2	Cl2	2.000	Two Points Calibration
Scl 3/10	Cl2	10.00	
Scl 3/20	Cl2	20.00	
Ecl 6,7,12,20	Cl2	10.00	Two Points Calibration
Scl 8/2	Clt	2.000	Two Points Calibration
Scl 8/20	Clt	20.00	
Scl 9/200	H2O2	200.0	
Scl 9/2000	H2O2	2000	
Scl 10/1	O3	1.000	
Scl 10/10	O3	10.00	
Scl 11/200	PAA	200.0	
Scl 11/2000	PAA	2000	
Scl 13	O2	60.00	
Scl 17/10	ClO2	10.00	
Scl 18/10	Cl2	10.00	
Ecl 6,7,12,20 br	Br2	10.00	Two Points Calibration
Scl 17/2	ClO2	2.000	Two Points Calibration
Scl 18/2	Cl2	2.000	Two Points Calibration
SBR 1/20	Br2	20.00	
SCL SC	Cl2	2.000	Two Points Calibration
Ecl 4,5,6,7,12	ClO2	10.00	Two Points Calibration
SCL 17/20	ClO2	20.00	
SCL 18/20	Cl2	20.00	
SCL 10/2	O3	2.000	Two Points Calibration
SCL 10/20	O3	20.00	
SCLT/2	ClO2	2.000	Two Points Calibration
SCL11/50	PAA	50.00	Two Points Calibration
SCL9/50	H2O2	50.00	Two Points Calibration
SCL2/0,5	ClO2	0,50	Two Points Calibration

Note: some probes aren't supported.

## Tracer calibration menu.

Tracer calibration procedure is based on two buffer solutions (0 BTSA and "working value" BTSA buffer solutions). According to installed probe, before calibration, configure the model using "Probe Tracer" menu.

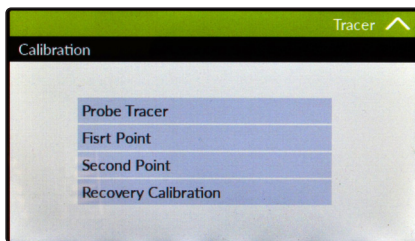
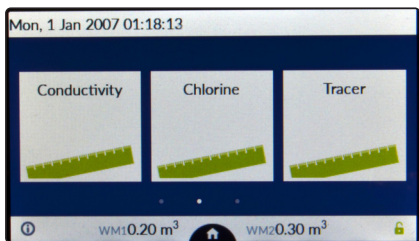

**Note:** This procedure assumes that CONTROLLER is correctly installed and configured, connected to a working probe. Calibrate using plant's temperature otherwise unattended results might occur. If something wrong occurs use RECOVERY CALIBRATION to restore to previous calibration.

### Two points calibration method.

During this procedure probe must be dry and clean and not installed in plant. Tap on "First Point" (zero) and confirm it. Tap on "Second point", dip probe's head into buffer solution and wait until reading value is stable, enter buffer solution value and confirm it. **Note:** buffer solution value may change if environment temperature it's different than 20°C. Read solution's label for more information. According to this occurrence "Default" must be changed. During calibration LIGHT could interfere with buffer solution reading value. Execute calibration in a dark environment.

## pH calibration menu.

pH calibration procedure is based on two buffer solutions (usually 7pH value for first point and 4pH value for second point).

### Calib 1st Point.

Once into calibration menu move tap on "First Point" then dip probe's sensor on 7pH buffer solution. Wait until reading value is stable and according to buffer solution value enter it on calibration field. ("Cal. at" field). Confirm it or discard if not satisfied. **Note:** buffer solution value may change if environment temperature it's different than 20°C. Read solution's label for more information. According to this occurrence "pH Default" must be changed. If something wrong occurs use RECOVERY CALIBRATION to restore to previous calibration.

### Calib 2nd Point.

Once into calibration menu move tap on "Second Point" then dip probe's sensor on 4pH buffer solution. Wait until reading value is stable and according to buffer solution value enter it on calibration field. ("Cal. at" field). Confirm it or discard if not satisfied. **Note:** buffer solution value may change if environment temperature it's different than 20°C. Read solution's label for more information. According to this occurrence "pH Default" must be changed. If something wrong occurs use RECOVERY CALIBRATION to restore to previous calibration.

## Temperature calibration.

For each channel, where available, there is a temperature probe to be used for proper probe's compensation. To calibrate the PT100 sensor a professional thermometer is required to obtain a reliable calibration. Within each channel calibration menu, tap on "Calib Temperature" to begin setup. Using an external thermometer to read actual temperature and enter value in calibration field. Confirm or discard changes. *Note: for pH calibration / Temperature compensation see curve at page 29.*

## Channels setpoints menu.

For each channel (except for CONDUCTIVITY) a setpoint configuration (for DIGITAL and PROPORTIONAL outputs) must be set to properly operate controller's outputs. It's also possible to set the related temperature setpoint for each channel (on/off mode only) and assign an output available.

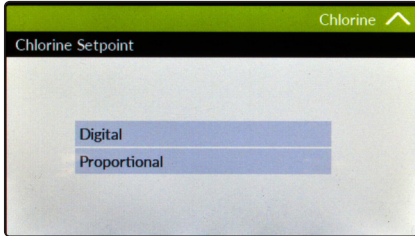

For each setpoint choose working mode.

### Parameters to set are:

- 1) Working mode (digital or proportional)
- 2) Values
- 3) Output (if available)
- 4) Pulses per Minute

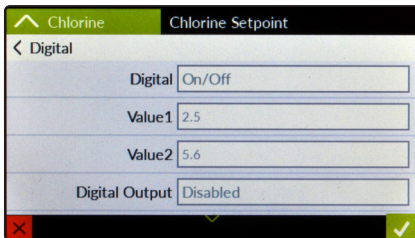

Digital Setpoint configuration sample having two values to work on.

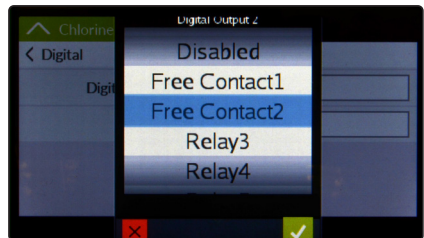

Digital outputs available.

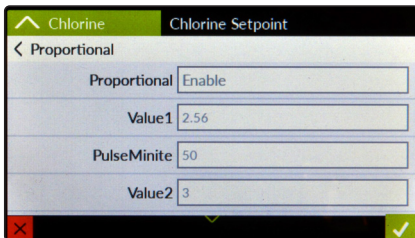

Proportional configuration sample having two values and pulses per minute to work on.

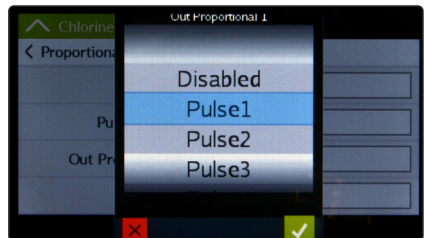

Proportional outputs available.

## “Set-Point CI” (PWM) mode - Digital

This mode is valid for any “Digital” output available. Pulse-width modulation (PWM) of a signal or power source involves the modulation of its duty cycle, to either convey information over a communications channel or control the amount of power sent to a load. This mode works over a settable (0 to 100 seconds) time to switch on or off selected output. During this time if reading value will move towards a set value (on or off) the PWM will operate the output on timered basis. Reaching the set value the PWM will permanently leave on or off the output. Parameters to set for this mode are:

**Unit Value + %:** (time activity towards set value. 0% means 0 seconds. 100% means 100 seconds.)

**CI range:** two CI values within PWM operates.

For example: set first CI value at 1.40 = 00% and second CI value at 0.80 = 60%.

For reading values  $\geq 1.40$  the output will be permanently OFF.

For reading values  $\leq 0.80$  the output will be ON for 60 seconds and OFF for 40 seconds.

If reading value is 1.1 mg/l then the output will be active at 30% (ON for 30 seconds, OFF for 70 seconds).

## “Set-Point CI” (on/off) mode - Digital

This mode is valid for any “Digital” output available. On/Off mode set the CONTROLLER to operate using two set values that enable or disable the CI pump. To use this mode tap on On/Off working mode. Tap on it.

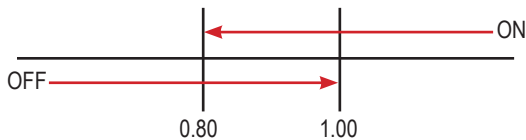

### ON/OFF mode

Set CI value at 0.80 mg/l ON and 1.00 mg/l OFF. The difference between the two CI values is called HYSTERESIS.

CONTROLLER will enable the Chlorine pump when reading value will decrease at 0.80mg/l

At 0.80mg/l the Chlorine pump will be enabled until reading value will increase at 1.00mg/l.

Pulse speed: to let pump operate at pulses per minutes add one or more minute (1pulse every xx minutes).

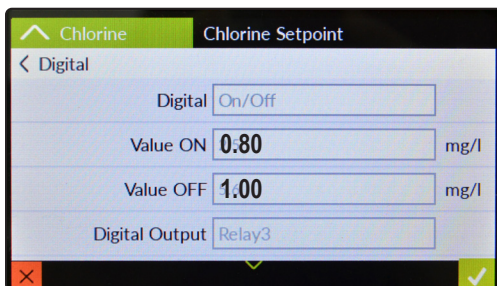

Tap on main function to enable / disable  
Tap on value to change them according to preferences  
Tap on Out to choose between any output available

## “Set-Point Cl” (Proportional) mode - Pulse

This mode is valid for any proportional / pulse output available.

Proportional mode set the CONTROLLER to operate using a calculated percentage between two set values that enable or disable the Cl pump. To use this mode tap on “Proportional First Point”. Tap on it.

**PROPORTIONAL mode between 1.00Cl (0 p/m) and 0.50Cl(180 p/m).** p/m is : pulses per minute

In this mode the Cl pump will be “ON” for values lower than 0.50mg/l with set pulses/minute capacity (e.g.: 180) and it'll be “OFF” for values greater than 1mg/l. For values of 0.75mg/l pump will be “ON” with 90 p/m capacity. The calculation is based on 180 pulse / minute.

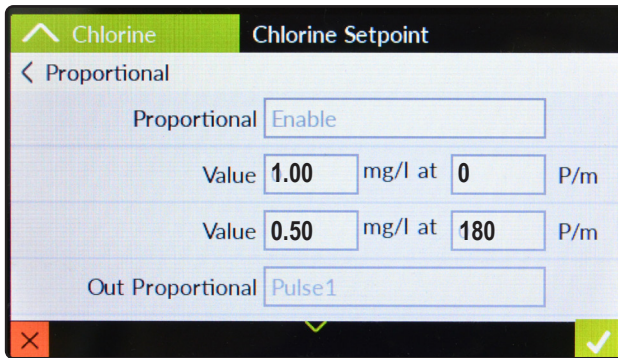

The screenshot shows a mobile application interface for configuring a Chlorine Setpoint. The screen has a black header with a green bar on the left containing a white upward-pointing triangle and the text "Chlorine". To the right of the header is the title "Chlorine Setpoint". Below the header is a white bar with a left-pointing triangle and the text "Proportional". The main content area has a light blue background and contains four rows of controls:

- Row 1: "Proportional" followed by a text input field containing "Enable".
- Row 2: "Value" followed by a text input field containing "1.00", "mg/l at", a text input field containing "0", and "P/m".
- Row 3: "Value" followed by a text input field containing "0.50", "mg/l at", a text input field containing "180", and "P/m".
- Row 4: "Out Proportional" followed by a text input field containing "Pulse1".

At the bottom of the screen, there is a black bar with a red 'X' icon on the left, a green checkmark icon in the center, and a green checkmark icon on the right.

Tap on main function to enable / disable  
Tap on value to change them according to preferences  
Tap on Out to choose between any output available

## “Set-Point pH” (on/off) mode ALKALI

This mode is valid for any “Digital” output available. On/Off mode set the CONTROLLER to operate using two set values that enable or disable the pH pump. To use this mode choose “Working Mode”. Tap on it.

### ON/OFF mode while dosing ALKALI

Set pH value at 7.00 OFF and 6.90 ON. Set Pulse Speed per minute (strokes per minute) based on dosing device capabilities. CONTROLLER will leave the pH pump active until reading value will increase up to 7.00pH.

At 7.00pH the pH pump will be disabled until reading value will decrease under 6.90pH.

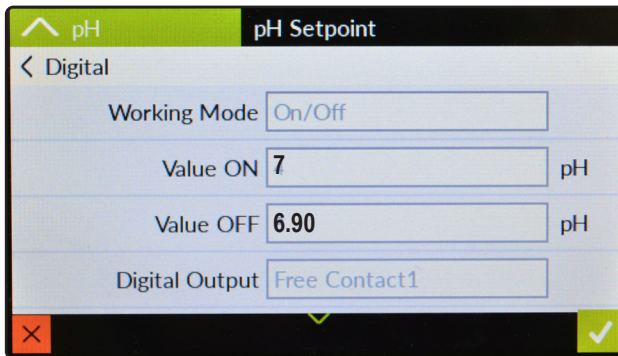
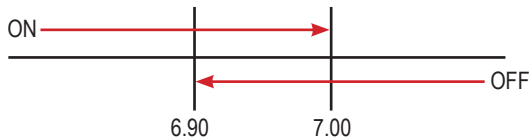

Tap on main function to enable / disable  
Tap on value to change them according to preferences  
Tap on Out to choose between any output available



## “Set-Point pH” (on/off) mode ACID

This mode is valid for any “Digital” output available. ON/OFF mode while dosing ACID

Set pH value at 7.00 OFF and 7.10 ON. Set Pulse Speed per minute (strokes per minute) based on dosing device capabilities.

CONTROLLER will leave the pH pump active until reading value will decrease up to 7.00pH

At 7.00pH the pH pump will be disabled until reading value will increase up to 7.10pH.

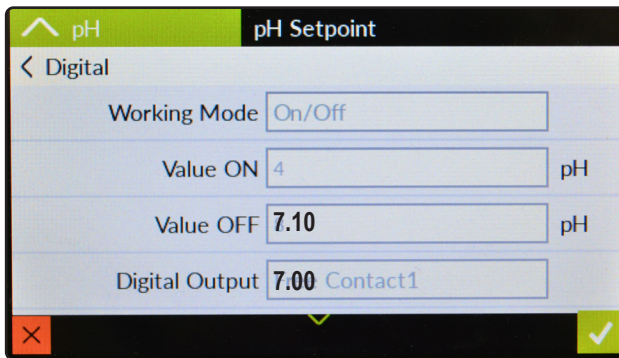
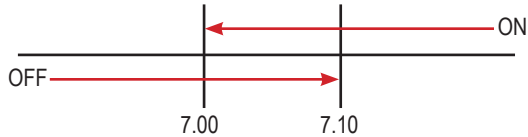

Tap on main function to enable / disable  
Tap on value to change them according to preferences  
Tap on Out to choose between any output available

---

### Did you know ?

In chemistry, an alkali is a basic, ionic salt of an alkali metal or alkaline earth metal element. Alkalis are best known for being bases (compounds with pH greater than 7) that dissolve in water. The adjective alkaline is commonly used in English as a synonym for base, especially for soluble bases. This broad use of the term is likely to have come about because alkalis were the first bases known to obey the Arrhenius definition of a base and are still among the more common bases. Since Brønsted-Lowry acid-base theory, the term alkali in chemistry is normally restricted to those salts containing alkali and alkaline earth metal elements.

An acid (often represented by the generic formula HA [H+A<sup>-</sup>]) is traditionally considered any chemical compound that, when dissolved in water, gives a solution with a hydrogen ion activity greater than in pure water, i.e. a pH less than 7.0. That approximates the modern definition of Johannes Nicolaus Brønsted and Martin Lowry, who independently defined an acid as a compound which donates a hydrogen ion (H<sup>+</sup>) to another compound (called a base). Common examples include acetic acid (in vinegar) and sulfuric acid (used in car batteries). Acid/base systems are different from Cl reactions in that there is no change in oxidation state.

## “Set-Point pH” (PWM)

This mode is valid for any “Digital” output available. Pulse-width modulation (PWM) of a signal or power source involves the modulation of its duty cycle, to either convey information over a communications channel or control the amount of power sent to a load.

This mode works over a settable (0 to 100 seconds) time to switch on or off selected output.

During this time if reading value will move towards a set value (on or off) the PWM will operate the output on timed basis. Reaching the set value the PWM will permanently leave on or off the output.

Parameters to set for this mode are:

**Unit Value + %:** (time activity towards set value. 0% means 0 seconds. 100% means 100 seconds.)

**pH range:** two pH values within PWM operates.

For example: set first pH value at 8.00 = 100% and second pH value at 4.0 = 0%.

For reading values  $\geq 8.00$  the output will be permanently ON.

For reading values  $\leq 4.0$  the output will be permanently OFF.

For reading value of 7.00 the output will be OFF for 25 seconds, ON for 75 seconds.

For reading value of 6.00 the output will be OFF for 50 seconds, ON for 50 seconds.

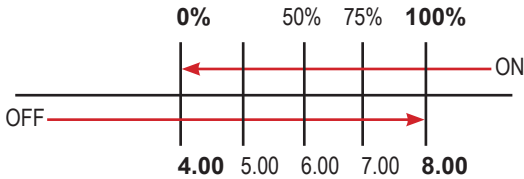

## “Set-Point pH” (Proportional) mode - Pulse

This mode is valid for any proportional / pulse output available.

Proportional mode set the CONTROLLER to operate using a calculated percentage between two set values that enable or disable the pH pump. To use this mode tap on “Proportional First Point”. Tap on it.

**PROPORTIONAL mode between 7pH(0 P/m) and 8pH (180 P/m).** p/m is : pulses per minute

In this mode the pH pump will be “ON” for values greater than 8pH with maximum set pulses per minute capacity (e.g.: 180) and it'll be “OFF” for values lower than 7pH. For values of 7.5pH pump will be “ON” with 90 pulses per minute capacity.

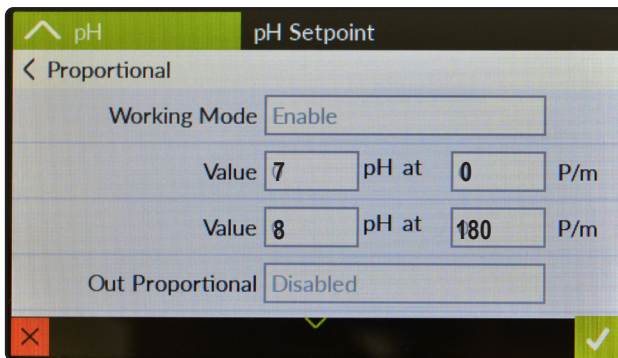

The screenshot shows a mobile application interface for configuring a pH controller. The title bar at the top is green and contains a back arrow, the text 'pH', and 'pH Setpoint'. Below the title bar, the screen is titled '< Proportional'. The configuration is as follows:

Working Mode	Enable		
Value	7	pH at	0 P/m
Value	8	pH at	180 P/m
Out Proportional	Disabled		

At the bottom of the screen, there is a red 'X' icon on the left and a green checkmark icon on the right.

## “Set-Point ppm” (on/off) mode example n.1 tracer

This mode is valid for any “Digital” output available. On/Off mode set the controller to operate using two set values that enable or disable the TRACER pump. To use this mode tap on “Working Mode”.

### ON/OFF mode example 1

Set ppm value at 7.00 OFF and 6.90 ON. Set Pulse Speed per minute (strokes per minute) based on dosing device capabilities. Controller will leave the tracer pump active until reading value will increase up to 7.00ppm. At 7.00ppm the tracer pump will be disabled until reading value will decrease under 6.90ppm.

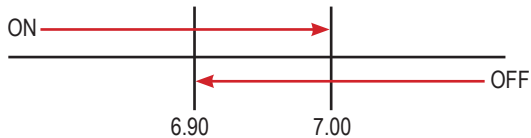

## “Set-Point ppm” (on/off) example n.2 tracer

This mode is valid for any “Digital” output available. ON/OFF mode

Set ppm value at 7.00 OFF and 7.10 ON. Set Pulse Speed per minute (strokes per minute) based on dosing device capabilities. Controller will leave the tracer pump active until reading value will decrease up to 7.00ppm. At 7.00ppm the tracer pump will be disabled until reading value will increase up to 7.10ppm.

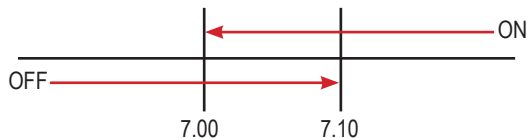

# “Centurio PRO” main menu: settings.

Main menu, Options are: Flow, Label, PASSWORD (see page 10), Flow meter, Log Setup and International (see page 35).

## “Flow Sensor”.

This menu allows to configure flow sensor contact (5 - 6 - 7/8).  
Options are:

**Mode:** Direct (N.O.), Reverse (N.C.), Disabled

**Delay:** starting delay time.

**Stop:** if enabled it stops controller when contact status changes.

**Message:** send alert message through message system.

**Log:** save status activity on logbook.

**Delay Send MSG:** Introduces a delay before sending a flow alarm message (0 disabled, max delay 999 minutes).

**Out Alarm:** Enable (yes) or disable (no) the output alarm when a flow sensor alarm occurs.

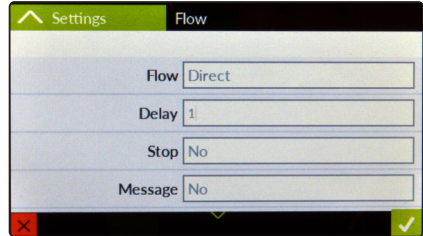

## “Label”.

This menu allows to name the controller to better identify it within a network / alerts messages.

**Default name:** “Centurio PRO”.

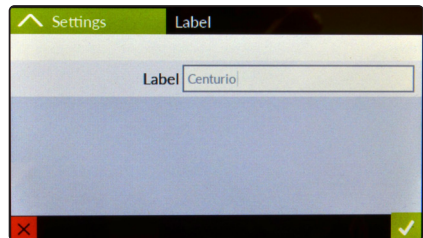

## “Flow Meters”.

This menu allows to configure WM1 and WM2 pulse sender water meters. Options are:

**Flow Meter, 20mA@Flow:** configuration & setup (see page 22)

**Proportional WM 1, 2, 3:** analog output configuration.

The proportional water meter menu allows to setup the flow meter to operate for dosing required PPM (parts per million) of product with a configurable % of product's concentration. Based on CC/ST (cc per strokes) of connected pump is possible to achieve dosing results of extreme precision.

**Reset Counter:** reset all water meters counters

**Timeout:** maximum time for calculation of water meter instant flow (20 to 999s).

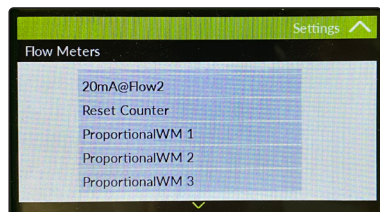
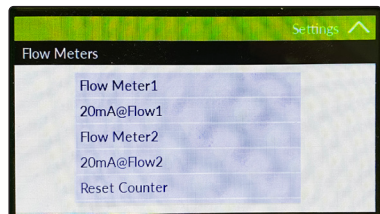

## “Flow Meters” settings.

This menu allows to configure **FlowMeter1** and **FlowMeter2** pulse sender water working modes. Options are:

**Factor:** based on mode “pulse / litre” or “litre / pulse” this option defines how many pulses made a liter or how many liters made a pulse.

**Mode:** Pulse / Litre or Litre / Pulse ratio setup

**Name:** Water Meter Name

**Alarm:** enable / disable controller’s alarm in main screen

**Time:** no flow time before to generate alarm

**Message:** send alert message through message system.

**Stop:** halt controller when changes status or not.

**Log:** save status activity on logbook.

**WM1 as Channel:** displays counter as channel in main screen. (restart required).

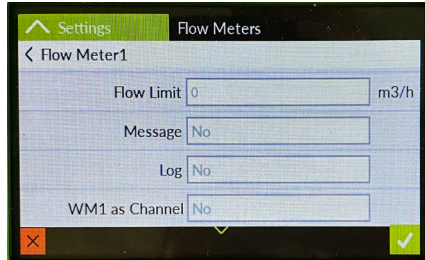
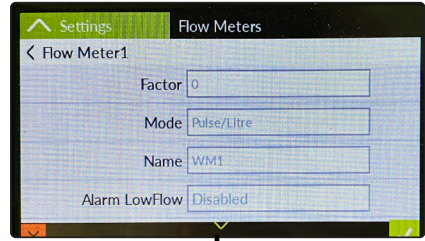

## “20mA@Flow” settings.

This menu allows to configure the available mA output proportionally to the value read by the meter having as reference 20mA and the set value.  
(E.g. : at 30m3 / h the output is at 20mA).

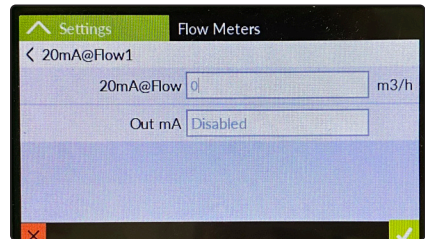

## “Probe Clean” settings.

This menu allows to configure the cleaning mode of probes with built in cleaning sensor. By assigning the relay to which the cleaning motor is connected you can set:

**Cycle Time:** time between one cleaning activity and the next

**Clean Time:** cleaning duration time

**Restore Time:** time to restore the probe reading functionality

**Relay:** relay connected to probe sensor cleaning motor

**Clean on alarm:** activate (enable) or deactivate (disable) a cleaning cycle following an alarm

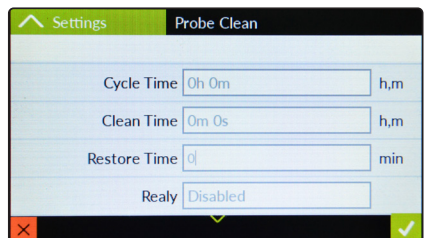

## pH / Temperature compensation curve.

pH measurements are temperature dependent. The degree to which temperature affects mV readings varies from solution to solution and can be calculated using the following graphic. Controller has either fixed or adjustable automatic temperature compensation referenced to a standard temperature of 25°C.

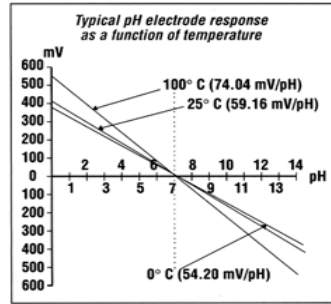

## “Timer” settings.

This menu allows to configure all the available outputs (proportional and digital) with a recurring / scheduled activation. For example, it is possible to assign outputs for water games, lighting.

Options are:

**Name:** timer name

**Digital Output:** choose between any available (relay or free contact) output or disabled

**Out Proportional:** choose between any available pulse output or disabled

**Pulse Minute (P/m):** pulses per minute

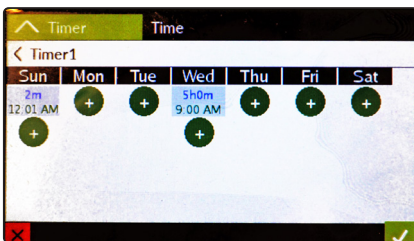
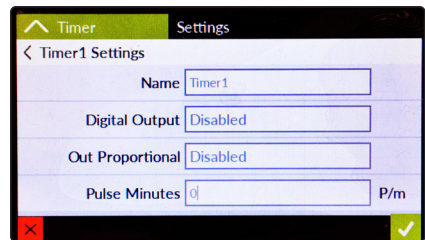
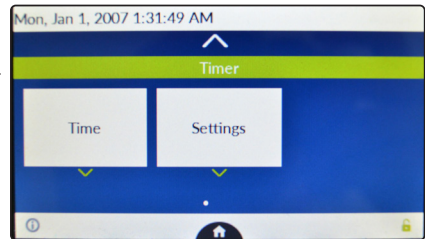

To setup time and day of activity tap on "Time" an add an event by tapping on "+" button.

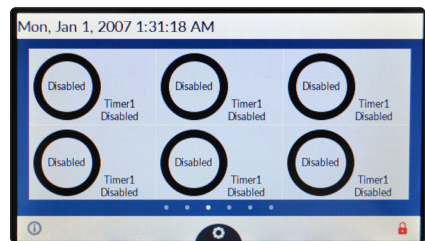

From main screen swipe to the left to check timered outputs status..

# “Centurio PRO” main menu: communication.

Main menu, Communication options are: ERMES, Mobile, Ethernet, Proxy, WiFi, Message and Modbus

## “ERMES”.

This menu allows to enable or disable “ERMES” remote management system. Option is ENABLED OR DISABLED. Before to enable it please configure at least one communication protocol between MOBILE, WiFi or Ethernet. Once the internet communication has been established, into main screen (see page 9) a confirmation icon will appears (e.g. ). Tap on it to complete “ERMES” configuration.

## “Mobile”.

This menu allows to configure the mobile communication when 3G/4G GSM module has been installed. Options are:

**PIN:** Enter SIM PIN number (if required)

**APN:** According to your mobile operator, if required, enter the access point name. Usually this field is automatically assigned.

**Username:** Enter SIM Username (if required)

**Password:** Enter SIM Password (if required)

**WARNING: THIS FUNCTION COULD NOT BE FREE OF CHARGE. DEPENDING ON YOUR DATA PLAN IT COULD GENERATE PAYING SMS and/or DATA TRAFFIC !**

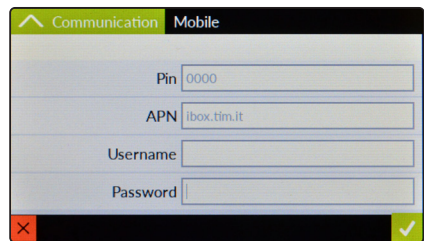

## “Ethernet”.

This menu allows to configure a cabled connection when an ethernet module has been installed. Usually a Dynamic configuration is suitable for most connections. Otherwise a Static configuration can be enabled according to LAN ADMINISTRATOR. If this is the case parameters to set are:

**IP:** static IP address assigned to the controller

**SubNet:** bitmask to encode the prefix length in quad-dotted notation

**Gateway:** (Internet) network node for outgoing connections

**DNS1 and / or DNS2:** server address for domain name and mapping

**Note: for MODBUS access over TCP/IP instruct PLC to reach port 502.**

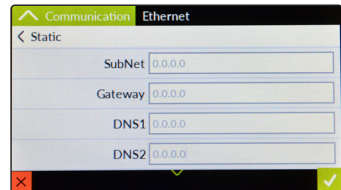
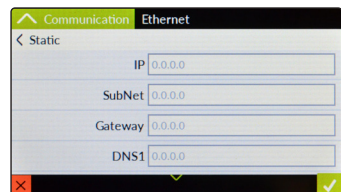
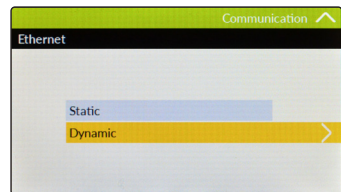



## “Proxy”.

This menu allows to configure the proxy server for the computer network service that allows clients to make indirect network connections to other network services. Ask to local ADMINISTRATOR about parameters to set.

In the most cases there is no need to configure this option.

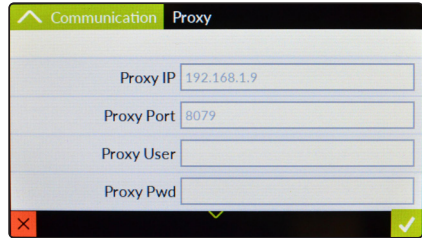

The screenshot shows the 'Proxy' configuration screen under the 'Communication' menu. It features four input fields: 'Proxy IP' with the value '192.168.1.9', 'Proxy Port' with '8079', 'Proxy User', and 'Proxy Pwd'. A green checkmark is visible in the bottom right corner, indicating the configuration is complete.

## “WiFi”.

This menu allows to configure the wireless internet communication service when a WiFi module has been installed. Usually the controller automatically begin to scan for all networks available. At the end of scanning procedure tap on preferred network name and, if needed, enter password. If preferred network SSID (name) is hidden, ask to local ADMINISTRATOR about parameters to set.

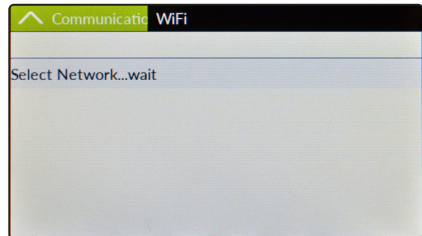

The screenshot shows the 'WiFi' configuration screen under the 'Communication' menu. The text 'Select Network...wait' is displayed, indicating the device is scanning for available networks.

## “Message”.

This menu allows to set up to 3 phone number and 3 email addresses for controller’s alert messages. This option requires an ETHERNET or WiFi or Mobile module installed and properly configured. Tap on SMS or Email to configure it.

Telephone number format must be international.  
(e.g.: +39344123456)

Email address format must be xxxx@xxxx

WARNING: THIS FUNCTION COULD NOT BE FREE OF CHARGE.  
DEPENDENT ON YOUR DATA PLAN IT COULD GENERATE  
PAYING SMS and/or DATA TRAFFIC IF MOBILE CONNECTED!

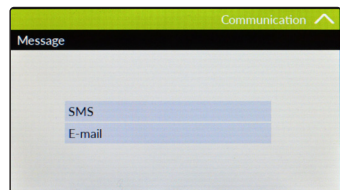

The screenshot shows the 'Message' configuration screen under the 'Communication' menu. It has two options: 'SMS' and 'E-mail', with 'SMS' currently selected.

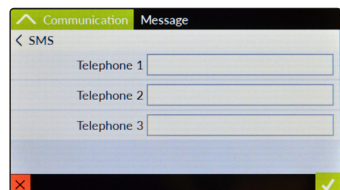

The screenshot shows the 'SMS' configuration screen under the 'Message' menu. It contains three input fields labeled 'Telephone 1', 'Telephone 2', and 'Telephone 3'.

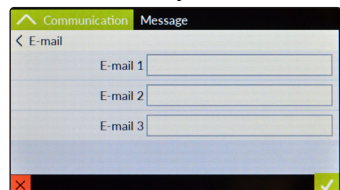

The screenshot shows the 'E-mail' configuration screen under the 'Message' menu. It contains three input fields labeled 'E-mail 1', 'E-mail 2', and 'E-mail 3'.

## “RS485” / “MODBUS”

From this menu you can choose how the RS485 connection works. To set the RS485 port to operate as MODBUS protocol, choose the “MODBUS” entry and proceed with the configuration. To connect the controller to another one choose between “RS485 MASTER” (the controller will be the primary one and it will provide communication services) or “RS485 SLAVE” (the controller will be connected to others and it will receive the communication services from the MASTER). See page 35 for connections.

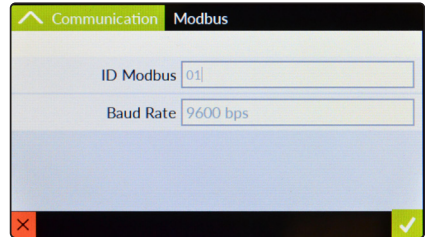

Modbus is a serial communications protocol originally published by Modicon (now Schneider Electric) in 1979 for use with its programmable logic controllers (PLCs). Simple and robust, it has since become a de facto standard communication protocol, and it is now a commonly available means of connecting industrial electronic devices. To configure this option a MODBUS module must be installed.

Set the ID assigning an UNIQUE address to avoid conflicts. According to connected device ensure that Baud Rate Speed is supported. Usually default value is the most suitable option.

---

### What is APN?

APN. Access point name (APN) identifies an IP packet data network (PDN), that a mobile data user wants to communicate with. In addition to identifying a PDN, an APN may also be used to define the type of service, (eg connection to wireless application protocol (WAP) server, multimedia messaging service (MMS)), that is provided by the PDN. APN is used in 3GPP data access networks, eg general packet radio service (GPRS), evolved packet core (EPC).

### What is a static IP address and a dynamic IP address?

A static IP address is a number (in the form of a dotted quad) that is assigned to a computer by an Internet service provider (ISP) to be its permanent address on the Internet. Computers use IP addresses to locate and talk to each other on the Internet, much the same way people use phone numbers to locate and talk to one another on the telephone. When you want to visit [whatis.com](http://whatis.com), your computer asks a domain name system (DNS) server (think telephone information operator) for the correct dotted quad number (think phone number) for [whatis.com](http://whatis.com) and your computer uses the answer it receives to connect to the [whatis.com](http://whatis.com) server.

It would be simple if every computer that connects to the Internet could have its own static IP number, but when the Internet was first conceived, the architects didn't foresee the need for an unlimited number of IP addresses. Consequently, there are not enough IP numbers to go around. To get around that problem, many Internet service providers limit the number of static IP addresses they allocate, and economize on the remaining number of IP addresses they possess by temporarily assigning an IP address to a requesting Dynamic Host Configuration Protocol (DHCP) computer from a pool of IP addresses. The temporary IP address is called a dynamic IP address.

Requesting DHCP computers receive a dynamic IP address (think temporary phone number) for the duration of that Internet session or for some other specified amount of time. Once the user disconnects from the Internet, their dynamic IP address goes back into the IP address pool so it can be assigned to another user. Even if the user reconnects immediately, odds are they will not be assigned the same IP address from the pool. To keep our telephone analogy going, using a dynamic IP address is similar to using a pay phone. Unless there is a reason to receive a call, the user does not care what number he or she is calling from.

There are times, however, when users who connect to the Internet using dynamic IP wish to allow other computers to locate them. Perhaps they want to use CU-SeeMe or use a VoIP application to make long distance phone calls using their IP connection. In that case, they would need a static IP address. The user has two choices; they can contact their ISP and request a static IP address, or they can use a dynamic DNS service. Either choice will probably involve an additional monthly fee.

Using a dynamic DNS service works as if there was an old-fashioned telephone message service at your computer's disposal. When a user registers with a DNS service and connects to the Internet with a dynamic IP address, the user's computer contacts the DNS service and lets them know what IP address it has been assigned from the pool; the service works with the DNS server to forward the correct address to the requesting DHCP computer. (Think of calling the message service and saying "Hi, I can be reached at 435.44.32.111 right now. Please tell anyone who tries to reach me to call that number.") Using a dynamic DNS service to arrange for computers to find you even though you are using a dynamic IP address is the next-best thing to having a static IP.

## “Graphics”.

“Centurio PRO” controller can graph readings value for every channel. Within main screen swipe to the left until option graphic screen is shown (see screenshot below). Tap on required graphic period (daily, weekly or monthly) and wait until all data are collected. Once the graphic has been shown tap on  to edit parameters (channel, date, time, etc...).

**Note:** based on amount of collected data / period, plotting time may be longer.

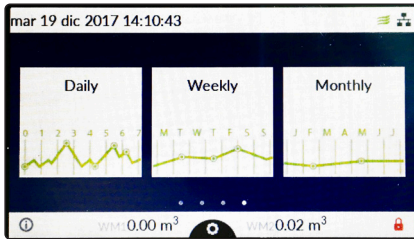

Choose

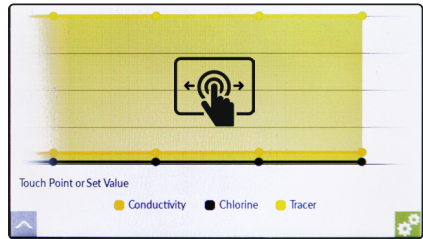

Plot



19/12/17 15:20				
Conductivity	23.6	Bleed Timeout	1	WM1
Chlorine	0.14			1
Tracer	100	Tracer High	1	
19/12/17 15:00				
Conductivity	23.6	Bleed Timeout	1	WM1
Chlorine	0.14			1
Tracer	100	Tracer High	1	

To alternate graphic / text view, swipe over graph

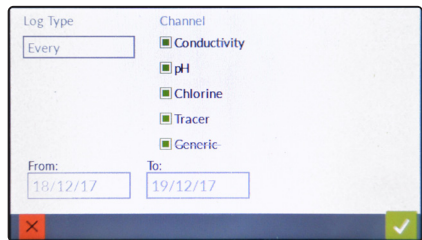

Log Type	Channel
Every	<input checked="" type="checkbox"/> Conductivity
	<input checked="" type="checkbox"/> pH
	<input checked="" type="checkbox"/> Chlorine
	<input checked="" type="checkbox"/> Tracer
	<input checked="" type="checkbox"/> Generic
From:	To:
18/12/17	19/12/17

Change

## “USB Pendrive”.

“Centurio PRO” controller can import / export data such as setpoint configuration (backup & restore), log activity and firmware update through USB port (located to the right side of the controller). Insert a *FAT32 previously formatted* pendrive and wait until the controller discover it. Then choose between available options to perform requested operation.



USB port is located at the side of controller's box



Pendrive required minimum size: 1GB.

## “CORROSION” Proportional Mode

When the ECORR probe is installed, the instrument can be configured to read and control the corrosion rate in the pipes of a plant. In the main menu, touch the corrosion icon to access the main options.

**Setpoint:** enable / disable control on inhibitor dosage

**Corrosion Level:** tank level of anti-corrosion product

**Corrosion Alarm:** alarm management for high corrosion values

**Settings:** selection of alloy factor for type of pipes

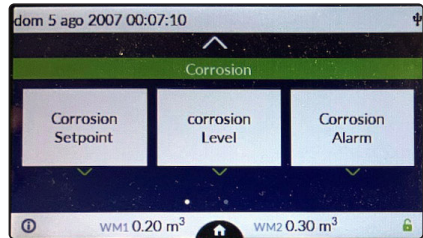

### “CORROSION SETPOINT”

This setpoint acts on the operating activity of the inhibitor if the instrument is set in WaterMeter PPM or CC / ST mode. For inhibitor control mode it is necessary to configure “Action Inhibitor”. For proportional mode operation configure the “Proportional” item.

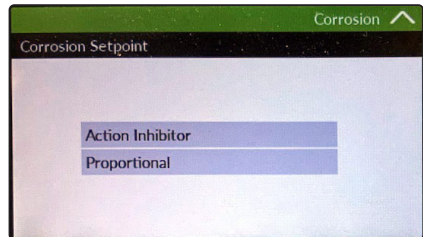

### Proportional (mode)

**Working Mode:** enable / disable proportional setpoint mode

**Limit:** MPY limit threshold after which the output is activated

**Pulse Minute:** activity in pulses / minute of the “IS” pump if the set limit is exceeded

**Out Proportional:** choice of the analogue output on which the pump is connected to restore corrosion values

**Name:** name of the activity

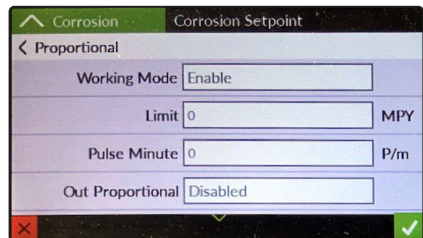

## CORROSION LEVEL

**Input:** enable / disable / select level probe input

**NO / NC:** sets the type of contact for the level probe input (normally open or normally closed)

**Stop:** Enable or disable controller's stop when contact changes state

**Name:** Name of the label

**Message:** Enable or disable alarm messages

**Log:** Enable or disable logging of the event log

Corrosion Level

Proportional Level

Input: Disabled

No/Nc: N.O.

Stop: No

Name: Level

Corrosion Level

Proportional Level

Stop: No

Name: Level

Message: No

Log: No

## CORROSION ALARM

**Absolute:** "absolute" alarm algorithm

**Track:** "track" alarm algorithm

Indifferently select one of the two modes to enable the alarm

Corrosion Alarm

Alarm High

Disabled

Absolute

Track

Corrosion Alarm

Alarm High

Alarm High: Absolute

ValueHigh: 9.25 MPY

Delay: 0h 0m h,m

Name: High

Corrosion Alarm

Alarm High

Name: High

Message: No

Stop: No

Log: Yes

Corrosion Alarm

Alarm High

Alarm High: Track

ValueHigh: 9.25 MPY

Delay: 0h 0m h,m

Name: High

**Alarm High:** Enable or disable the alarm

**ValueHigh:** Corrosion limit value (MPY units)

**Delay:** Activation delay time

**Stop:** Enable or disable activity block if active

**Message:** Enable or disable alarm messages

**Log:** Enable or disable logging of the event log

**Label:** Name of the label

## “SETTINGS” / “ALLOY FACTOR” (SETTINGS / ALLOY)

Based on the construction material of the pipes, select the most suitable alloy factor value according to the following table:

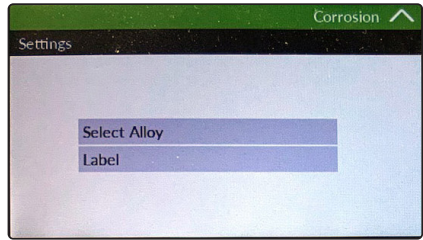
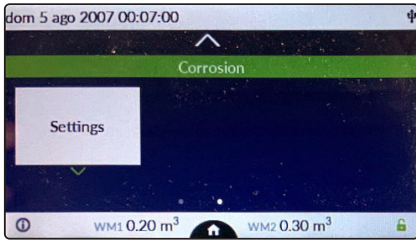

It is possible to assign a name to the type of material by selecting the LABEL item.

Common Designation	UNS	Alloy Factor
Aluminum AA1100	A91100	0.94
Aluminum Alloy AA6061	A96061	0.94
Copper CDA110	C11000	2.00
Arsenical Admiralty Brass CDA443	C44300	1.67
Mild Steel C1010	G10100	1.00
Stainless Steel 304	S30400	0.89

# “Centurio POOL”

The POOL version of the CENTURIO controller includes some exclusive features for dosing and controlling the water in the pool. These features include “FLOCCULANT”, “FILTRATION”, “CHLORINE” and a single channel for temperature reading based on pH module. In the pH setting submenu (pH / Settings) it is also possible to set the pH priority over the chlorine dosage.

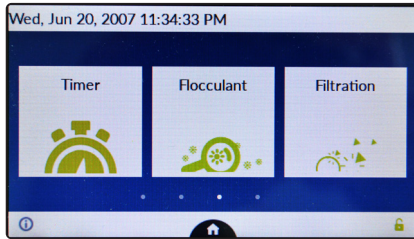

## “Flocculant” (flocculation for the removal of colloidal particles)

Through this menu (Settings, Flocculant) it is possible to configure the entire flocculation procedure to remove all the colloidal material.

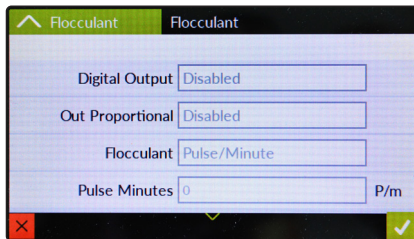

In order to correctly set this mode, it is necessary to select between the digital and analog outputs those to be used for the connection of the flocculation equipment, set the measurement unit (pulses per minute or minutes per pulse) and the Pulses per Minute to be produced during flocculant activity.

## “Filtration” (dechlorination from pool’s filters)

Through this menu (Settings, Filtration) it is possible to configure the dechlorination pump from pool’s filters.

The screenshot shows the 'Dechloration Purge' configuration screen under the 'Filtration' menu. It contains four input fields: 'Input' set to 'Disabled', 'No/Nc' set to 'N.O.', 'Name' set to 'filter', and 'Relay' set to 'Disabled'. A red 'X' icon is in the bottom left corner, and a green checkmark icon is in the bottom right corner.

The screenshot shows the 'Pressure Filter' configuration screen under the 'Filtration' menu. It contains four input fields: 'Differential' set to '0' with 'PSI' units, 'Backwash' set to '0h 0m' with 'h,m' units, 'Name' set to 'Differential', and 'Relay' set to 'Disabled'. A red 'X' icon is in the bottom left corner, and a green checkmark icon is in the bottom right corner.

The screenshot shows the 'Time Filter' configuration screen under the 'Filtration' menu. It contains a list of menu items: 'Timer1', 'Timer1 Settings', 'Timer2', and 'Timer2 Settings'.

In order to correctly set this functionality, it is necessary to select the input level from those available that will activate the pump, the type of contact (N.O normally open or N.C. normally closed), assign a name and select the relay output related to the pump. In the “Pressure Filter” menu it is possible to set the pressure differential for the dechlorination activity (eg: values above 30PSI / 2bar), the duration of the washing (Backwash in hours, minutes) the name and the relay on which pressure sensor is active (mA module). Optionally it is possible to set a weekly timer for scheduled dechlorination activity.

## “Chlorine” (shock chlorination activity)

Through this menu (Settings, Chlorine) it is possible to set a daily / weekly timer to activate shock chlorination.. This procedure allows you to disinfect the water effectively, destroying the polluting elements that cause turbid water, bad smell or algae proliferation.

The screenshot shows the 'Chlorine' main menu under the 'Settings' menu. It contains three menu items: 'Shock Chlorination Schedule', 'Shock Chlorination Settings', and 'Combinated'.

The screenshot shows the 'Shock Chlorination Settings' configuration screen under the 'Settings' menu. It contains three input fields: 'HOLD' set to '0h 0m' with 'h,m' units, 'Pump' set to 'Disabled', and 'Pump Time' set to '0h 0m' with 'h,m' units. A red 'X' icon is in the bottom left corner, and a green checkmark icon is in the bottom right corner.

Parameters to set are: in the “Chlorination Schedule” submenu the days / hours when shock chlorination activity occurs and in the “Chlorination Settings” submenu the waiting time after shock chlorination procedure (HOLD) before returning to normal dosing activity, the relay on which the pump for chlorination activity (PUMP) is connected, the duration of the pump activity for chlorination shock (PUMP TIME). In the “CHLORINE” menu it is also possible to set the display of the combined chlorine (difference between total chlorine and free active chlorine, necessary for the detection of organic and inorganic nitrogen-based pollutants).



## Dissociation of hypochlorous acid related to pH value

The pH represents an index of the acidity of a solution. From a chemical point of view, the pH indicates the base10 of the concentration of H<sup>+</sup> ions present in a solution and therefore the ability of the solution itself to accept OH<sup>-</sup> and neutralize them. In practice, a low pH solution is ACID, while a high pH solution is BASIC. The pH value is expressed with a pure number, without a unit of measurement.

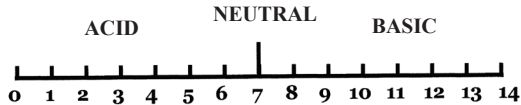

The pH value of swimming pool water is very important to be monitored and controlled constantly. For example, the result of a too high pH is to literally throw the chlorine that we put into the water, because it will have no effect. The reason is given by the fact that the hypochlorous acid, i.e. the disinfectant substance that is released from all the chlorine-based products introduced into the tank water, is not stable but tends to dissociate continuously according to the reaction:



The dissociation of hypochlorous acid is strongly influenced by the pH value of the water, as shown in the graph below:

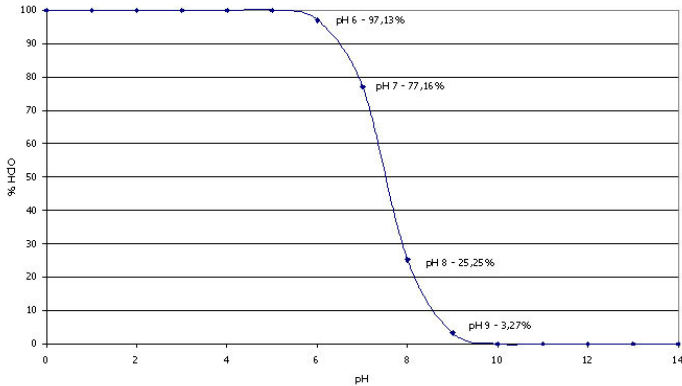

With a pH around 6 the dissociation in practice does not take place, while if it rises above the value of 7.5 surely at least half of the hypochlorous acid present in the solution will dissociate. Since for an effective water disinfection it is important that the molecule remains undissociated and the dissociation depends heavily on the pH value, so the need to keep the pH under control becomes one of the fundamental aspects of the chemical conditioning of the pool.

Within the “**TEMPERATURE / SETTINGS**” menu, there is a submenu visible only if Chlorine probes\* capable of managing this function are connected to the controller, enable the “**% Active Chlorine**” item on “**SHOW**” to display the percentage of Active Chlorine detected.

\*SCL 1/2, SCL 1/5, SCL 1/20, SCL 1/200, SCL 1/2, ECL 6,7,12,20, ECL 6,7,12,20 BR, SCL 18/10, SCL 18/2, SCL 18/20

## Laser Level Sensor (via 485)

The SLL laser level sensor allows stable and reliable quantity detection of liquids in different sizes. It is also capable of detecting simply by distance, regardless of shape, color or surface finish. Shaft PVC made. This feature makes this sensor ideal for detecting the quantity of products in the tanks without any dependence on density, viscosity, color or degree of transparency. Connect the sensor to the instrument as described on page 43. The meter will automatically detect the new probe. Confirm by selecting the check mark.

From the main menu select „TANK“ and proceed with the configuration of the tank assigned to the sensor by selecting the item „Settings“. In this menu it is possible to set the type of tank (Select Tank), reset the previously entered configuration parameters (Reset Tank) or assign a custom name to the tank (Label Tank).

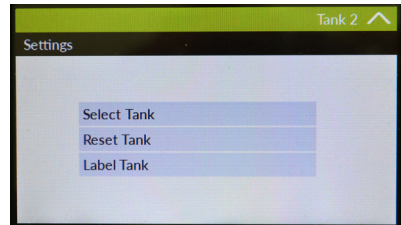
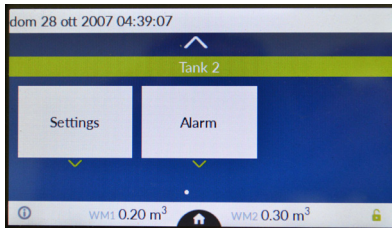

If the tank is not listed (CNTxx) it is possible to assign a generic tank and proceed to its configuration. From the menu „Select Tank“ select „GENERIC“. In the following screen it will be possible to configure the tank capacity parameters.

### Tank.

Tank name.

### Tank Min

Minimum product threshold.

Enter liters of the minimum product value related to the height from above. Eg.: At 90mm there are 5 liters of product.

### Tank Max

Maximum product threshold.

Enter liters of the maximum product value related to the height from above. Eg.: At 30mm there are 40 liters of product.

### Current Probe

Value in mm of the product currently read.

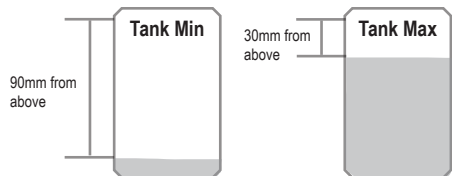
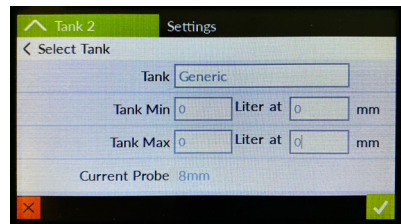

**LED Status from SLL.** The green LED shows the connection status as follows:

LED fast blinking: sensor not associated to controller

LED slow blinking: sensor connected, standby mode

LED on: working sensor



# Laser Level Sensor (via RS485) - Alarm Management

From the container menu (TANK) select the „Alarm“ item and set the configuration parameters as follows:

### Alarm Low.

Enable (Enable) or Disable (Disable) the alarm for low product in tank.

### Limit

Defines the minimum level of product in the tank in liters for the activation of the level alarm.

### Delay

Defines in hours and minutes the delay time between detection of the minimum level of product in the tank e activation of the level alarm.

### Label

Assigning the name of the tank.

### Stop

If set to „Yes“ the work activity of the instrument stops and an alarm message is generated.

If set to „No“ a message is generated alarm but the instrument’s activity is not interrupted.

### Message

If set to „Yes“ an alarm message is sent to the recipient configured in the communication menu.

### Log

If set to „Yes“, it records sensor operation activity in the event log as configured in the communication menu.

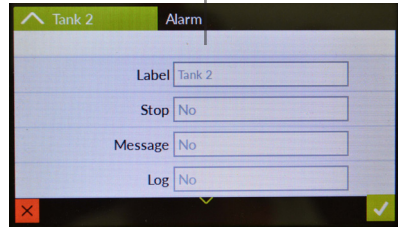
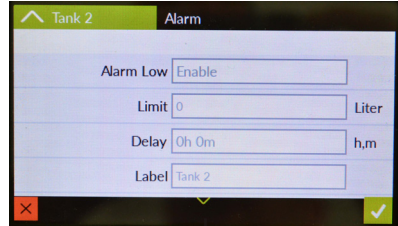

## Circulation

From settings menu select „Circulation“ to connect an external device to one of the available relays outputs. Tap on „enable“ to activate it. Output will be always active when Centurio is on.

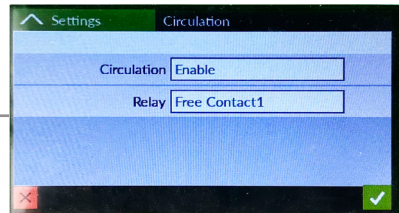
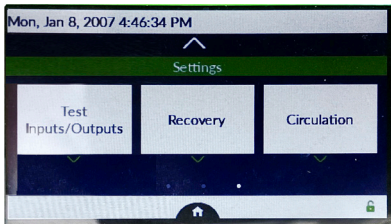

## Appendix - Probes Modules

CD

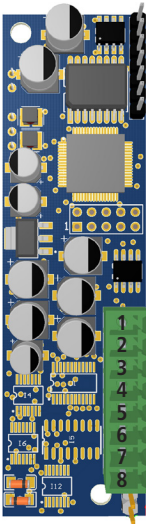

This module is suitable for CONDUCTIVITY PROBE

- 1) n/a
- 2) PT100 yellow wire
- 3) PT100 white wire
- 4) PT100 brown wire
- 5) PT100 green wire
- 6) CD PROBE out red wire
- 7) CD PROBE in black wire
- 8) CD PROBE gnd

- 2) + 3) PT100 white wire
- 4) + 5) PT100 green wire
- 6) SONDE CD red wire
- 7) SONDE CD black wire
- 8) SONDE CD gnd

For ECDHLCPT/1

mA

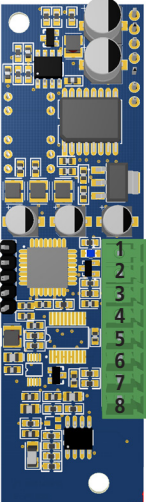

This module is suitable for mA EXTERNAL DEVICE / TRACER (10862021)

- 1) GND (i.e. black wire for tracer probe)
- 2) +12VDC (i.e. red wire for tracer probe)
- 3) PT100 yellow wire
- 4) PT100 white wire
- 5) PT100 brown wire
- 6) PT100 green wire
- 7) -mA signal INPUT (i.e. brown / green wire for tracer probe)
- 8) +mA signal INPUT (i.e. orange wire for tracer probe)



Warning: Connections must be performed by qualified and trained personnel only

## Appendix - Probes Modules

### CDIND / CDINDS

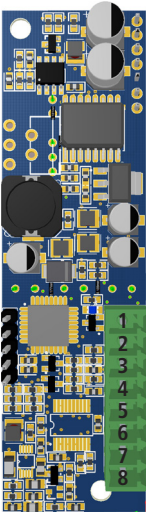

#### Connection for CD INDUCTIVITY PROBE

- 1) n/a
- 2) PT100 green wire
- 3) PT100 orange or pink wire
- 4) PT100 white wire
- 5) PT100 yellow wire
- 6) PROBE power supply red wire
- 7) PROBE signal grey wire
- 8) PROBE gnd blue and black wire

#### Connection for CD INDUCTIVITY PROBE mod. "S"

- 1) n/a
- 2) PT100 white wire
- 3) PT100 white wire
- 4) PT100 black wire
- 5) PT100 black wire
- 6) PROBE power supply red wire
- 7) PROBE signal green wire
- 8) PROBE gnd blue wire

### pH

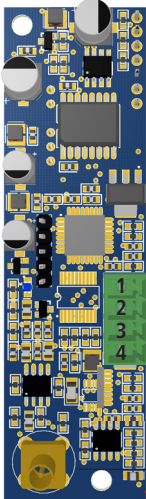

#### This module is suitable for pH / ORP / Florine probes

- 1) PT100 yellow wire
- 2) PT100 white wire
- 3) PT100 brown wire
- 4) PT100 green wire

Probe Input



Warning: Connections must be performed by qualified and trained personnel only

## Appendix - Probes Modules

CL

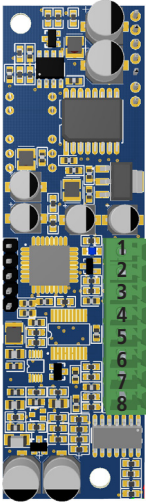

This module is suitable for SVCL PROBE (suitable also for OPEN CELLS ECL6):

- 1) -12VDC white wire SVCL probe
- 2) +12VDC brown wire SVCL probe
- 3) PT100 yellow wire
- 4) PT100 white wire
- 5) PT100 brown wire
- 6) PT100 green wire
- 7) +mV SVCL probe green wire (or ECL6 red wire)
- 8) -mV SVCL probe yellow wire (or ECL6 black wire)

CLDO

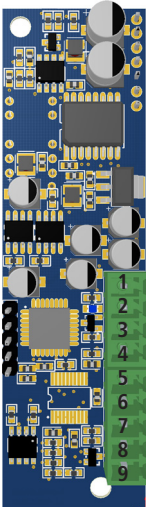

This module is suitable for following probes:

### SCL

### DISSOLVED OXYGEN\*

- |                          |                         |
|--------------------------|-------------------------|
| 1) PT100 yellow wire     | 1) PT100 yellow wire    |
| 2) PT100 white wire      | 2) PT100 white wire     |
| 3) PT100 brown wire      | 3) PT100 brown wire     |
| 4) PT100 green wire      | 4) PT100 green wire     |
| 5) n/a                   | 5) DO probe yellow wire |
| 6) GND SCL black wire    | 6) DO probe grey wire   |
| 7) +5VDC SCL red wire    | 7) DO probe brown wire  |
| 8) -RS485 SCL green wire | 8) DO probe blue wire   |
| 9) +RS485 SCL white wire | 9) DO probe pink wire   |

\*without extra plug cable



Warning: Connections must be performed by qualified and trained personnel only

## Appendix - Probes Modules

### POTENTIOSTATIC

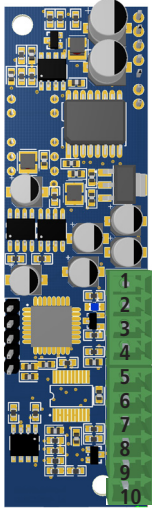

This module is suitable for POTENTIOSTATIC probe:

- 1) PT100 external: Yellow wire
- 2) PT100 external: White wire
- 3) PT100 external: Brown wire
- 4) PT100 external: Green wire
- 5) n/a
- 6) n/a
- 7) n/a
- 8) WE
- 9) RE
- 10) CE

### TURBIDITY

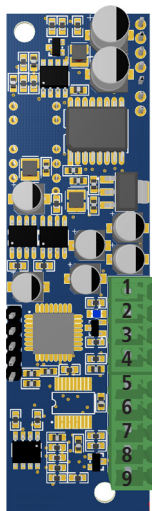

This module is suitable for TURBIDITY probe:

- 1) PT100: Yellow wire
- 2) PT100: White wire
- 3) PT100: Brown wire
- 4) PT100: Green wire
- 5) Torb Probe: Red wire
- 6) Torb Probe: Black + Blue wires
- 7) n/a
- 8) Torb Probe: White wire
- 9) Torb Probe: Yellow wire

## Appendix - Probes Modules

### ETO40

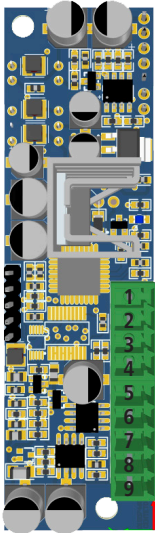

This module is suitable for ETO40 TURBIDITY probe:

- 1) PT100: Yellow wire
- 2) PT100: White wire
- 3) PT100: Brown wire
- 4) PT100: Green wire
- 5) Torb Probe: Blue wire
- 6) Torb Probe: Brown wire
- 7) Torb Probe: Black wire
- 8) Torb Probe: White wire
- 9) Torb Probe: Green wire

### ETRC2 / ECORR MODULE

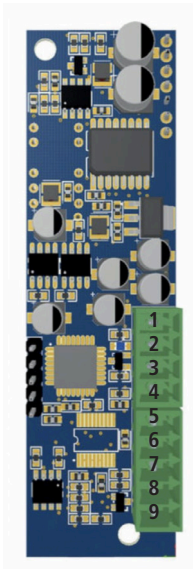

This module is suitable for ETRC2 / ECORR\* (10887911) probes:

- 1) from external PT100: Yellow wire (ETRC2 probe only)
- 2) from external PT100: White wire (ETRC2 probe only)
- 3) from external PT100: Brown wire (ETRC2 probe only)
- 4) from external PT100: Green wire (ETRC2 probe only)
- 5) Red Wire 24 +VDC
- 6) Black or Brown\* Wire 24 -VDC
- 7) n/a
- 8) Yellow Wire RS-485 B
- 9) Blue Wire RS-485 A



## Appendix - Dimensions (mm)

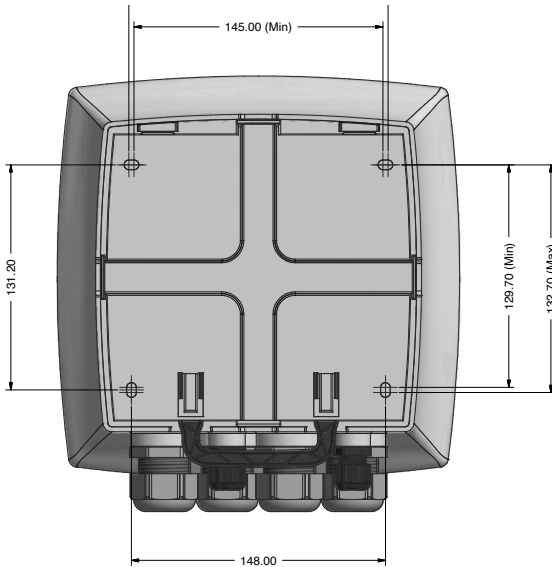
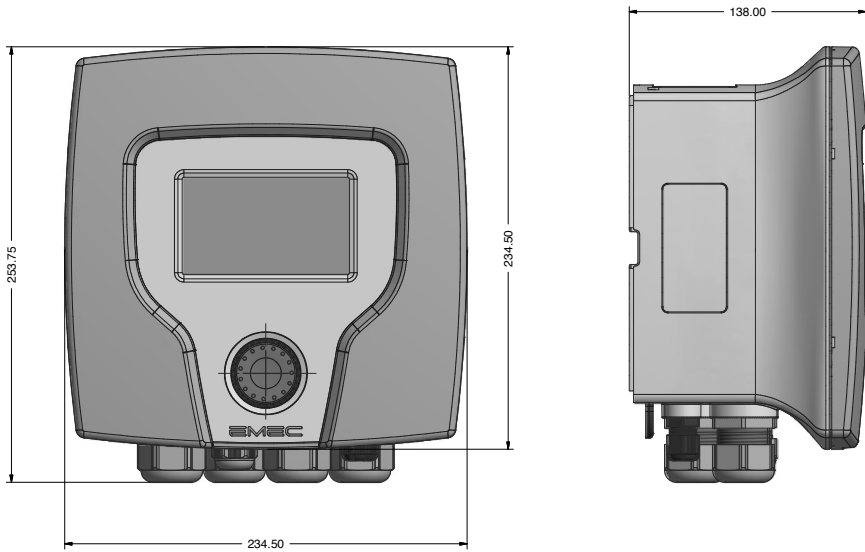

### ENCLOSURE

IP65 enclosure (NEMA4x)  
Centurio PRO control CONTROLLER is manufactured in ABS housing to ensure protection against aggressive chemicals and tough environment.

### ENVIRONMENT

-10°C ÷ 50°C (14°F ÷ 122°F)  
0 ÷ 95% (non condensing)  
relative humidity

## Appendix - Lock / Unlock from the wall mounting rack

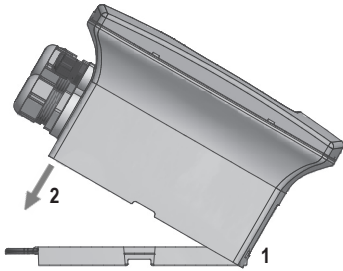

**LOCK**

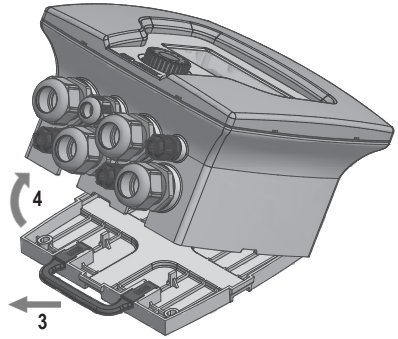

**UNLOCK**

To **lock** controller to the wall gently insert (1) upper case to the wall mounting rack and move it (2) down until it locks to the lower part of the wall mounting rack.

To **unlock** controller from the wall pull (3) the handle from the wall mounting rack and raise up (4) the controller.

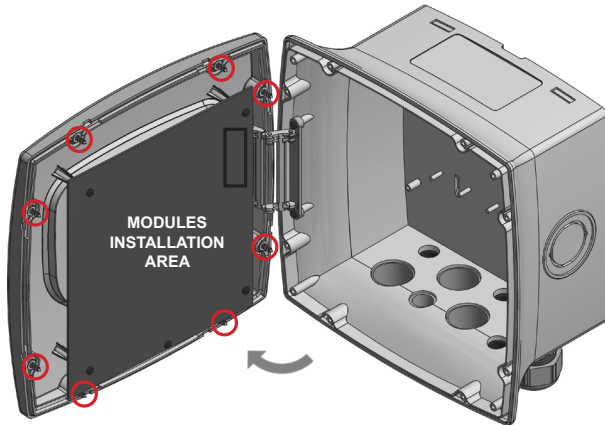

## Appendix - Passing the wires through the cable-retaining ring

For the passage of the cables / wires through the rubber pad, it is necessary to make a cut in correspondence of the hole in order to favor the entrance of cable. Once the cable is inserted, it is possible to reassemble the rubber with the cable clamp by screwing it back to the controller box.

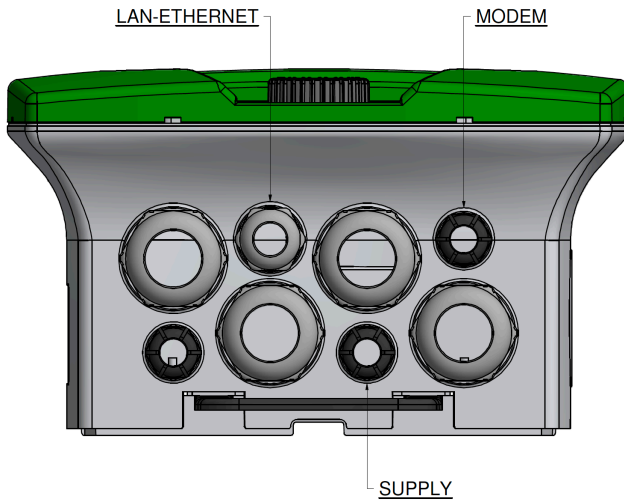

## Appendix - Adding / Removing probe modules / optionals / mA

To remove or add a new probe's module, first disconnect the controller from main power supply then remove the white front cover by pulling it. Unscrew the 8 screws and open main panel as shown in figure p.38 to gain access to modules. Install the new module to any slot available or remove unwanted modules by unscrewing it from main board. Slots order shown on the display is progressive from left to right.

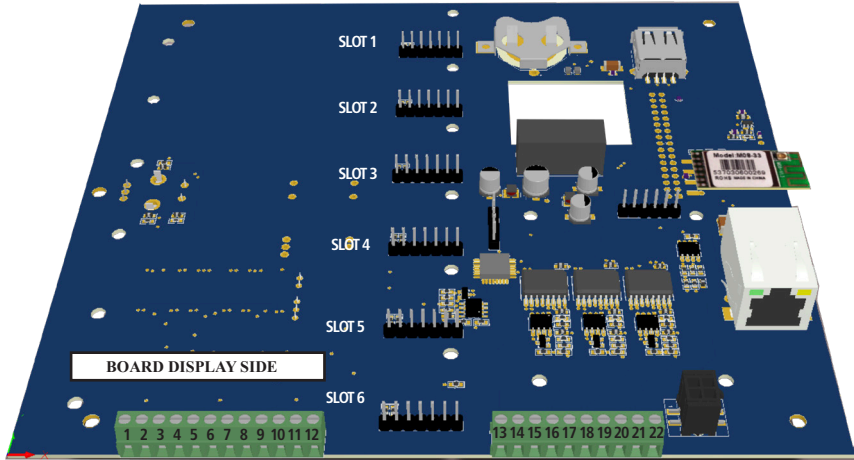

### I/O Connections:

1: mA Output n.6 n/a  
 3: mA Output n.5  
 5: mA Output n.4  
 7: mA Output n.3  
 9: mA Output n.2  
 11: mA Output n.1  
 2 / 4 / 5 / 8 / 10 / 12: GND

#### mA Outputs

13: GND (black / blue wire)  
 14: VDC (red wire)  
 15: -RS485 (B) (green / white\*)  
 16: +RS485 (A) (white / yellow\*)

**LEVEL LASER  
 SENSOR COMMUNICATION BUS / SERIAL PROBES**  
 \*immersion probe only

17: -RS485 (B)  
 18: +RS485 (A)  
 19: GND

**COMMUNICATION PORT  
 LEGACY CONTROLLERS (LD - LDS SERIES)**

20: -RS485 (B)  
 21: +RS485 (A)  
 22: GND

**COMMUNICATION PORT  
 Centurio PRO - Centurio POOL - LDOSIN SERIES - MODBUS**

## Appendix - Adding / Removing communication modules

To remove or add a communication module, first disconnect the controller from main power supply then remove the white front cover by pulling it. Unscrew the 8 screws and open main panel as shown in figure to gain access to modules connectors.

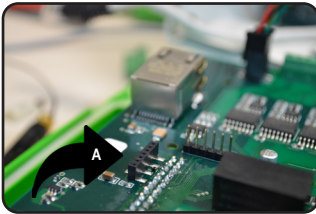
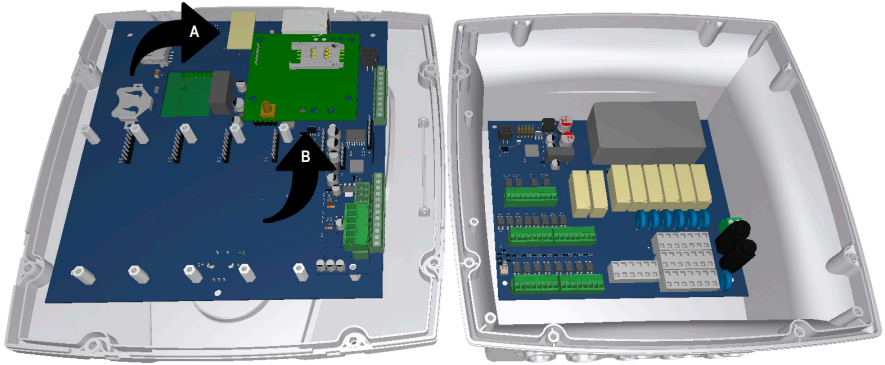

### A. WiFi Module Installation

Insert the module on the connector highlighted in the figure. Make sure that the antenna is properly connected.

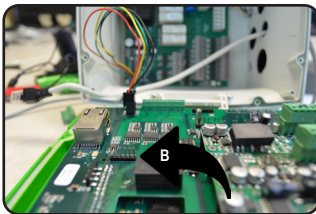
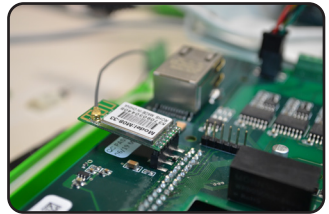

### B. MODEM (SIM) installation

Insert the module on the connector highlighted in the figure. Make sure that SIM is correctly inserted and active. Secure the module with the supplied screws.

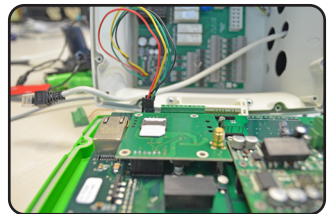

## Appendix - DO (dissolved oxygen) calibration

Sensor calibration is NOT required. However, if unattended results occurred, the slope calibration of the oxygen sensor can be performed in air, saturated water or using a reference solution.

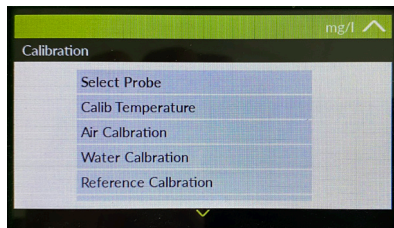

### Calibration in AIR.

Calibration in air is only possible if air temperature is  $\geq -5$  °C ( $\geq 23$  °F). Choose "RANGE" to setup reading scale. Choose "AIR" as calibration method within "Mode" menu. Remove sensor from the medium and dry completely. Leave it in air. Start calibration by clicking on . Reading value is real time displayed on upper screen side. 600s means how many seconds are left until the end of procedure. Move cursor on "ESC" when "CALIBRATION OK" message appears. If an error message appears repeat procedure.

### Calibration in air saturated WATER.

Choose "RANGE" to setup visualization scale. Choose "WATER" as calibration method within "Mode" menu. Dip head's probe into water. Start calibration by clicking on . Reading value is real time displayed on upper screen side. 600s means how many seconds are left until the end of procedure. If an error message appears repeat procedure.

### Calibration using a REFERENCE solution.

Choose "RANGE" to setup visualization scale. Choose "REF" as calibration method within "Mode" menu. Dip sensor's probe into reference solution. Start calibration by clicking on . Reading value is real time displayed on upper screen side. 600s means how many seconds are left until the end of procedure. If an error message appears repeat procedure.

### Probe's temperature sensor calibration.

Temperature calibration needs an external thermometer to match probe's reading value. Move wheel on "Temp probe", press wheel to enter system temperature obtained from a thermometer. See next page for in-depth description. Press wheel to confirm then move cursor on "ESC" and press wheel. End procedure by moving cursor on "Exit" from "Temp probe" main menu and press it. If an error occurred during calibration procedure then the instrument will show an error message and will ask to proceed to a new calibration, cancel current operation or restore default settings.

To restore probe's calibration parameters to factory values select "Rerence Calibration" menu.

## Appendix - NTU (turbidity) calibration

To obtain correct reading values for the turbidity probe it is possible to set: probe SELECT PROBE (selectable working scale), calibration of the NTU probe based on two points (first point and second point), calibrate the temperature of the internal sensor or reset the original NTU calibration values (recovery calibration).

The turbidity sensor is shipped already calibrated (plug & play) so it usually does not need to be calibrated. However by selecting "NTU" and "Calibration" it is possible to perform a two point calibration.

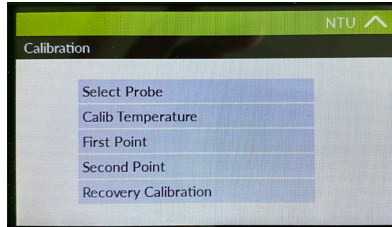

First Point: zero value or theoretical minimum. Immerse the probe tip in a 0NTU solution and press the knob when the reading is stable.

Second Point: slope or value close to the working one. Immerse the probe tip in a known buffer solution and enter the value in the "Cal." at "when the reading is stable.

Please read the instructions provided by the probe manufacturer for best results.

The probe is equipped with a temperature sensor. To calibrate, select "Calib Temperature" and enter the value read by a thermometer used as a reference in the system.

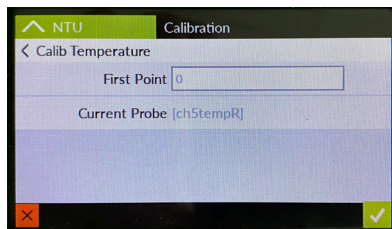

# Appendix - Logical Working Scheme (pool)

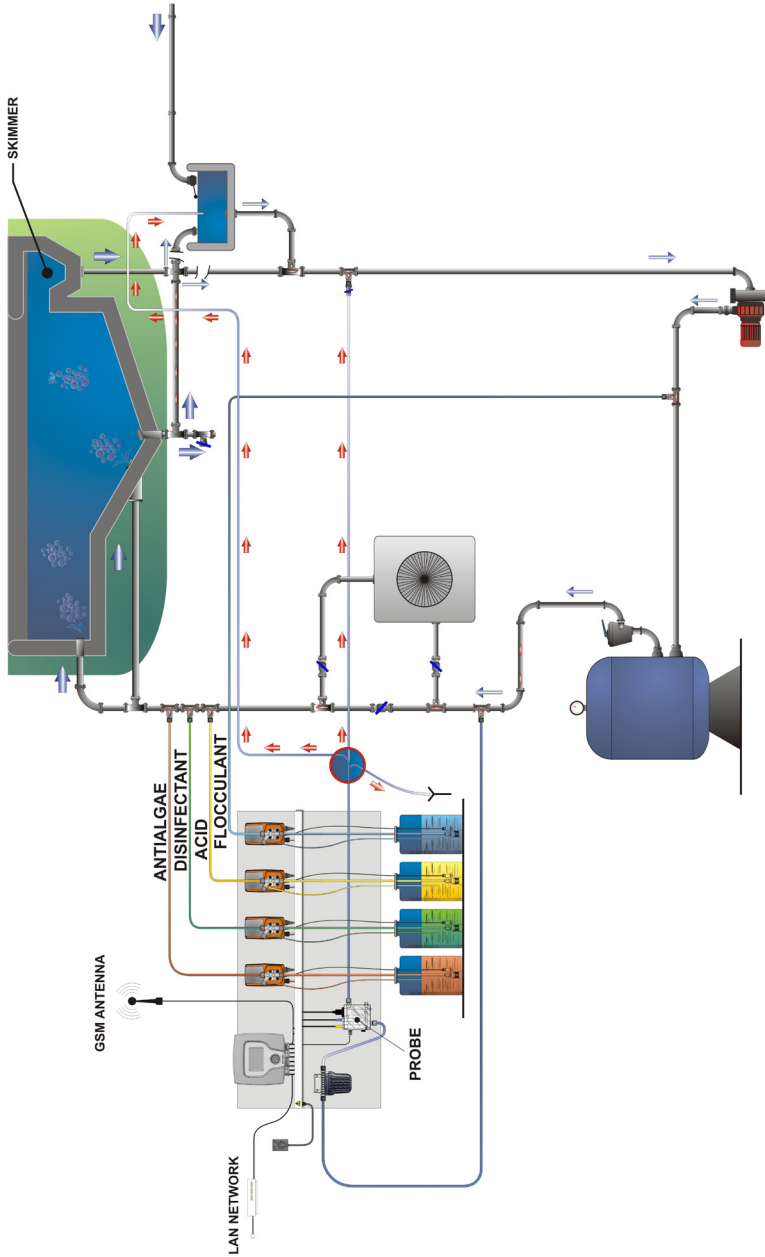



# INDEX

<b>INTRODUCTION</b>	page 3	
The wheel and the touch screen	page 3	
<b>MAINBOARD CONNECTIONS</b>	page 4	
“Centurio PRO” main screen	page 6	
“Centurio PRO” basic settings	page 7	
“International” menu	page 8	
<b>“Centurio PRO” STANDARD SETTINGS</b>	page 9	
“Calibration” menus	page 9	
“Setpoints” menus	page 13	
“Settings” menu	page 21	
<b>“Communication” ADVANCED SETTINGS</b>	page 24 { ERMES Mobile Ethernet Messages WiFi Proxy	
“Graphics” menu		page 27
“USB” pendrive setup		page 27
<b>“CENTURIO PRO” anticorrosion config. settings</b>		page 28
<b>“CENTURIO POOL” configuration settings</b>		page 31
<b>APPENDIX - Probes modules connection</b>	page 32	
Laser Level Sensor (RS485)	page 34	
Circulation (always on output)	page 35	
<b>APPENDIX - DIMENSIONS</b>	page 37	
<b>APPENDIX - WALL mounting and modules installation</b>	page 38	
Advanced mainboard connection	page 40	
DO Module Calibration (Dissolved Oxygen)	page 46	
NTU Module Calibration (Turbidity)	page 47	
Logical working scheme	page 48	
<b>INDEX</b>	page 43	

**DICHIARAZIONE DI CONFORMITA' UE** CE  
**DECLARATION OF CONFORMITY UE** CE  
**DECLARACIÓN DE CONFORMIDAD UE** CE

La società:  
The Company:  
Sociedad:

**EMEC s.r.l.**

Indirizzo della Società:  
Company Address:  
Dirección de la empresa:

**Via Donatori di Sangue, 1**

**DICHIARA**, sotto la propria responsabilità, che il prodotto:  
**DECLARES**, under its own responsibility, that the product:  
**DECLARA**, bajo su responsabilidad que el product:

Descrizione del prodotto:  
Product description:  
Descripción del producto:

Strumenti di Controllo, serie:  
Control Instruments, series: "CCS", "WQCT", "LDxx", "Lxx", "Jxx", "Wxx",  
"DINxx", "OSINx", "M-TOWER", "MAX5, GECL", "CENTURIO".  
Instrumentos de control, serie de:

Sono conformi alle seguenti norme:  
Conform to the following standards:  
Ajustarse a las normas siguientes:

**NORME CE/EC RULES(STANDARD EC)/NORMAS DE LA CE**

Direttiva Bassa Tensione/Low Voltage Directive/Directiva de baja tensión (2014/35/UE)  
Direttiva EMC Compatibilità Elettromagnetica/EMC electromagnetic compatibility directive/EMC directiva de compatibilidad electromagnética (2014/30/UE)

EN ISO 12100, Sicurezza del macchinario/Safety of Machinery/Seguridad de las máquinas,  
EN 809, Pompe e gruppi di pompaggio per liquidi-Requisiti di sicurezza/Pumps and pumping units for liquids-Safety requirements/Bombas y unidades de bombeo para líquidos-los requisitos de seguridad  
I nostri strumenti di misura per la temperatura, il pH, il potenziale redox, il cloro attivo libero, il cloro attivo combinato e l'acido isocianurico rientrano nei requisiti della norma UNI 10637/Our measuring instruments for temperature, pH, ORP, free chlorine, combined chlorine and isocyanuric acid meet UNI 10637 requirements/Nuestros instrumentos de medición de temperatura, pH, Redox, cloro libre, cloro combinado y ácido isocianúrico respetan UNI 10637 requisitos.

I prodotti hanno superato il collaudo finale.  
The products have passed the final test.  
Los productos han superado la prueba final.

Data:  
Date: 08/11/2018  
Fecha:

Firma:   
Signature: **Cogli Claudio – Presidente EMEC S.r.l.**  
Firma:

EMEC S.r.l.  
via Donatori di Sangue, 1  
02100 Rieti - Italia  
T +39 0746 22841  
F +39 0746 22842

Sede legale  
Corso Vittorio Emanuele II, 15  
20122 Milano - Italia

info@emec.it - www.emec.it

P.IVA e Cod Fisc. 00620840579 | Registro imprese Milano REA MI-2050351





*When dismantling this product please separate material types and send them according to local recycling disposal requirements.  
We appreciate your efforts in supporting your local Recycle Environmental Program.  
Working together we'll form an active union to assure the world's invaluable resources are conserved.*